

C31212VGBCH04 Datasheet

IC LED Series (L* W*H): 1.25*1.25*0.42mm

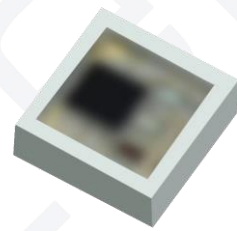

Applications

- Point light source, guardrail tube
- Status indicator
- Signal and symbol luminary
- Front panel backlighting
- Lens color: White diffused
- Full-color strip
- Indoor decorative lighting/ curtain display
- Indoor display screen

Features

- RoHS Compliant
- EIA STD package
- Constant current output, R/G/B current can be controlled separately, single channel up to 12mA,
- Built-in high-precision and high-stability oscillator
- Preconditioning: accelerate to JEDEC level 3
- Single line double channel serial level connection port, using zero - return code
- Serial data frequency is 1300Khz adjustable,
- Grayscale adjustment R/G/B single channel can support 65536 levels of adjustment
- Built-in data shaping function: After receiving the data of this unit, subsequent data shaping will be output automatically
- Built-in overvoltage protection
- The damage of a single lamp does not affect the signal transmission of the next LED (by pass)
- R/G/B monochrome supports 16bit data
- The recommended number of serial connections is 430PCS
- Prevent side astigmatism, high luminous aggregation

C31212VGBCH04

Dimensional Drawing

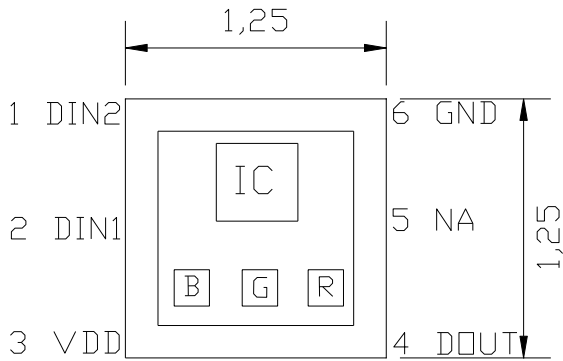

Top view

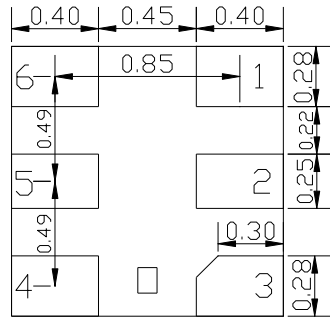

Side view



Bottom view

Recommended Solder Pad

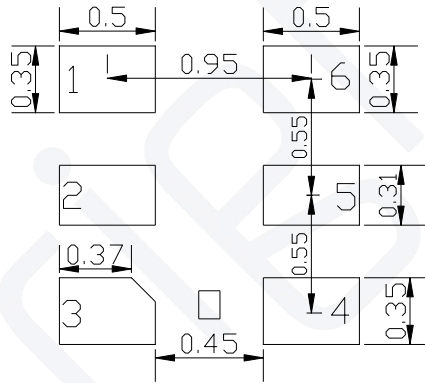

1. Dimensions are in millimeters.
2. General tolerance is $\pm 0.1\text{mm}$.

No.	Symbol	Function description
1	DIN2	Control data signal input2
2	DIN1	Control data signal input1
3	VDD	Power supply LED
4	DOUT	Control data signal output
5	NA	Insignificance
6	GND	Ground

C31212VGBCH04

Naming Rule

C3-1212-VGB-C-H-04

C3	1212	VGB	C	C	04
Process Type	Lead Frame Size	Dice wavelength	Cap Color	Spectral Condition Code	Flow Code
C3: With FC IC series	1212: 1.25*1.25mm	V: red G: green B: blue	C: water transparent	H: 3.63mA	04: no expression above meaning for company

Maximum Ratings

T_A : 25 °C

Parameter	Symbol	Values	Unit
Forward current	I _F	12	mA
IC Power Supply Voltage	V _{DD}	+3.5~+7.5	V
R/G/B output port withstand voltage	V _{ds}	9	V
IC Input Voltage	V _I	-0.5~+5.5	V
Operating Temperature Range	/	-40°C to +85	°C
Storage Temperature Range	/	-40°C to +105	°C
Soldering temperature	T _{SD}	260	°C
ESD voltage resistance	V _{ESD}	5	Kv

1. The maximum of soldering time is 10 seconds in T_{SD}.

C31212VGBCH04

Characteristics

VDD:5V | T_A : 25 °C

Characteristics	Symbol	Min.	Typ.	Max.	Unit	Test condition	
Luminous Intensity	I _v	R	50	70	150	mcd	IF=3.63mA
		G	210	310	620		IF=3.63mA
		B	40	65	120		IF=3.63mA
		W	300	460	600		IF=10.89mA
Dominant Wavelength	λ _d	R	615	-	630	nm	IF=3.63mA
		G	515	-	530		IF=3.63mA
		B	460	-	475		IF=3.63mA
Color Coordinate	x	-	0.2342	-	-	IF=10.89mA	
	y	-	0.2626	-	-		
View Angle	2θ _{1/2}	-	120	-	-	IF=10.89mA	

1. Luminous intensity is measured with a light sensor and filter combination that approximates the CIE eye-response curve.
2. 2θ_{1/2} is the off-axis angle at which the luminous intensity is half the axial luminous intensity.
3. The dominant wavelength, λ_d is derived from CIE chromaticity diagram and represents the single wavelength which defines the color of the device. Peak Emission Wavelength Tolerance is ±1nm.
4. We will amend the Bin code to maintain Bin Code centralize and we get the Luminous Intensity is 1.3 double per Bins.

C31212VGBCH04

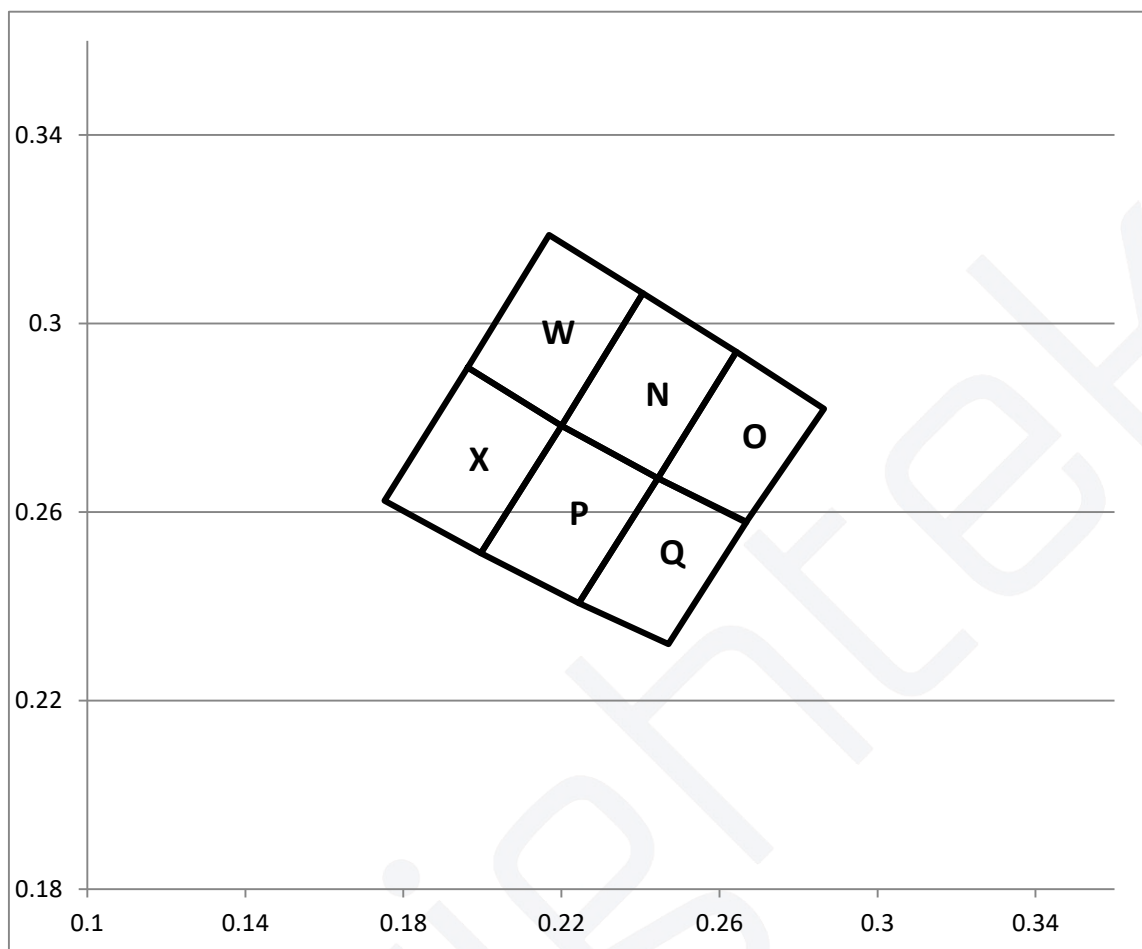

Bin	X	Y	X	Y	X	Y	X	Y
W	0.1963	0.2907	0.2169	0.3188	0.2406	0.3064	0.22	0.2783
N	0.22	0.2783	0.2406	0.3064	0.2643	0.294	0.2444	0.2672
X	0.1963	0.2907	0.1752	0.2624	0.1996	0.2513	0.22	0.2783
P	0.22	0.2783	0.1996	0.2513	0.2244	0.2407	0.2444	0.2672
O	0.2444	0.2672	0.2643	0.294	0.2865	0.2819	0.2667	0.2578
Q	0.2444	0.2672	0.2244	0.2407	0.2471	0.232	0.2669	0.2579

Tolerance of X/Y : ± 0.005

C31212VGBCH04

Electrical Characteristics

T_A : 25 °C

Characteristics	Symbol	Condition	Min.	Typ.	Max.	Unit
Chip input voltage	V _{DD}	-	3.5	5	7.5	V
R/G/B output drive current	I _o	V _{ds} =1V	0.71	3.63	12	mA
Input voltage level	V _{IH}	D _{IN} , Input high level voltage	0.7V _{DD}	-	-	V
	V _{IL}	D _{IN} , Input low level voltage	-	-	0.3V _{DD}	V
Current offset (interchannel)	d _{io}	V _{ds} =1V , I _o =12mA	-	±1.5	±3	%
Current offset (inter chip)	d _{io}	V _{ds} =1V , I _o =12mA	-	±3	±5	%
Current offset (VS-V _{ds})	%VS.V _{ds}	1V<V _{ds} <3V		±0.1	±0.5	%
Current offset (VS-V _{DD})	%VS.V _{DD}	4.5V<V _{DD} <5.5V		±1	±2	%
Dynamic current loss	I _{DD.dyn}	Data input. Turn off the lights	-	-	0.7	mA
Quiescent current	I _{DD}	No data input. Turn off the lamp	-	-	5	uA

Switching Characteristics

T_A : 25 °C

Characteristics	Symbol	Condition	Min.	Typ.	Max.	Unit
Rate of data signal	F _{DIN}	V _{DD} =5V	-	1	1.3	MHz
Oscillation frequency	F _{osc}	V _{DD} =5V	-	800	-	KHz
PWM frequency	F _{PWM}	-	-	4	-	KHz
Output current conversion time	T _r	V _{ds} =1.5V	-	-	60	ns
	T _f	I _o =12mA	-	-	60	ns
Transmission delay time	T _{PLZ}	DIN→DO	-	-	200	ns

C31212VGBCH04

Current gain regulation

RGB gain setting	RGB output (mA)
0	0.71
1	1.07
2	1.46
3	1.81
4	2.18
5	2.55
6	2.94
7	3.30
8	3.63
9	3.98
A	4.36
B	4.74
C	5.11
D	5.48
E	5.87
F	6.24
10	6.47
11	6.83
12	7.22
13	7.60
14	7.96
15	8.34
16	8.73
17	9.08
18	9.40
19	9.77
1A	10.15
1B	10.54
1C	10.9
1D	11.27
1E	11.67
1F	12.00

C31212VGBCH04

Data transfer time

1. Timing Wave Form

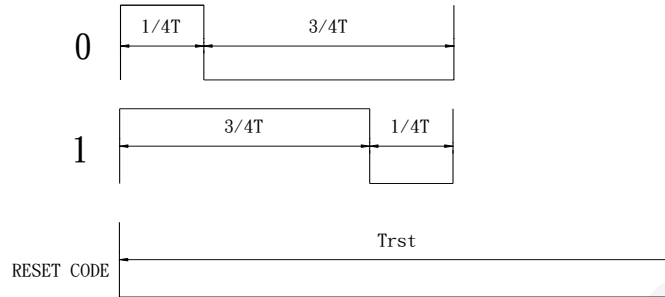

2. Data transfer time

Item	Description	Typical	Allowance
T_{0H}	0 code, high voltage time	$0.24\mu s$	$\pm 10\%$
T_{0L}	0 code, low voltage time	$0.48\mu s$	$\pm 10\%$
T_{1H}	1 code, high voltage time	$0.48\mu s$	$\pm 10\%$
T_{1L}	1 code, low voltage time	$0.24\mu s$	$\pm 10\%$
RES	reset time	$\geq 80\mu s$	-

3. Composition of 48bit data

R15	R14	...	R1	R0	G15	G14	...	G1	G0	B15	B14	...	B1	B0
-----	-----	-----	----	----	-----	-----	-----	----	----	-----	-----	-----	----	----

LED brightness 48bits data structure, high bit is sent first, and data is sent in the order of RGB

GR4	GR3	GR2	GR1	GR0	GG4	GG3	GG2	GG1	GG0	GB4	GB3	GB2	GB1	GB0
-----	-----	-----	-----	-----	-----	-----	-----	-----	-----	-----	-----	-----	-----	-----

RGB gain 15bits data structure, high bit is sent first, and data is sent in the order of RGB

3.1 Data transmission method

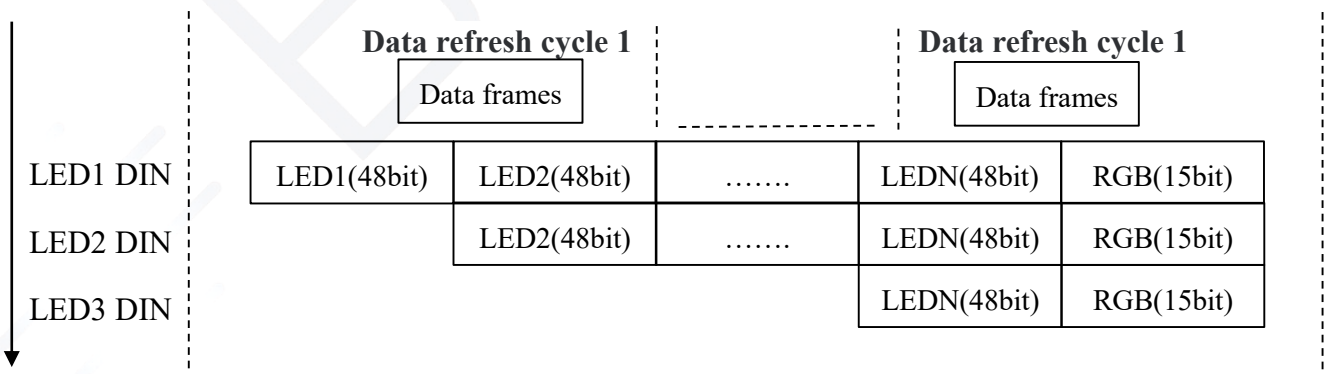

Note: The data frame D(1) is the data sent by the MCU, and D(2) and D(N) are the data that the cascade circuit automatically reshapes and forwards.

Reflow Soldering Profile

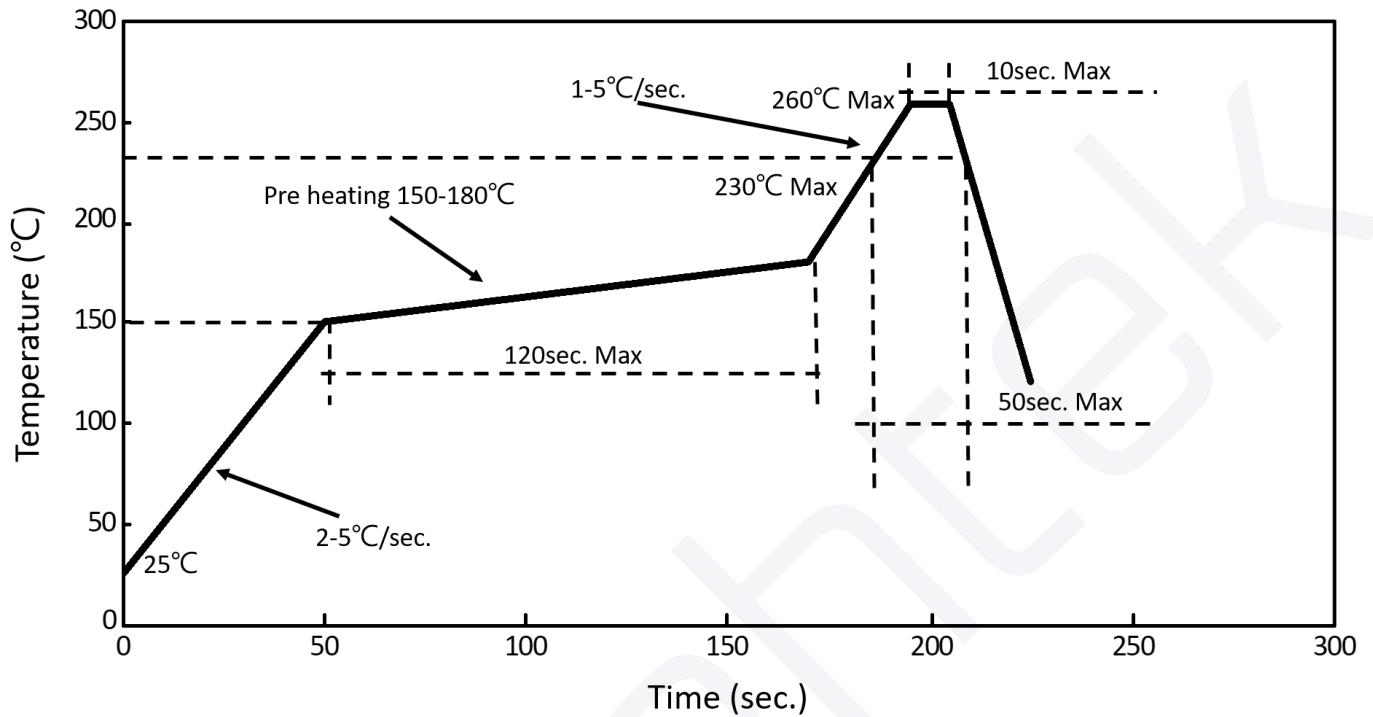

1. We recommend the reflow temperature 240°C ($\pm 5^\circ\text{C}$).the maximum soldering temperature should be limited to 260°C.
2. Do not stress the silicone resin while it is exposed to high temperature.
3. The reflow process should not exceed 3 times.

Test Circuit and Precautions for

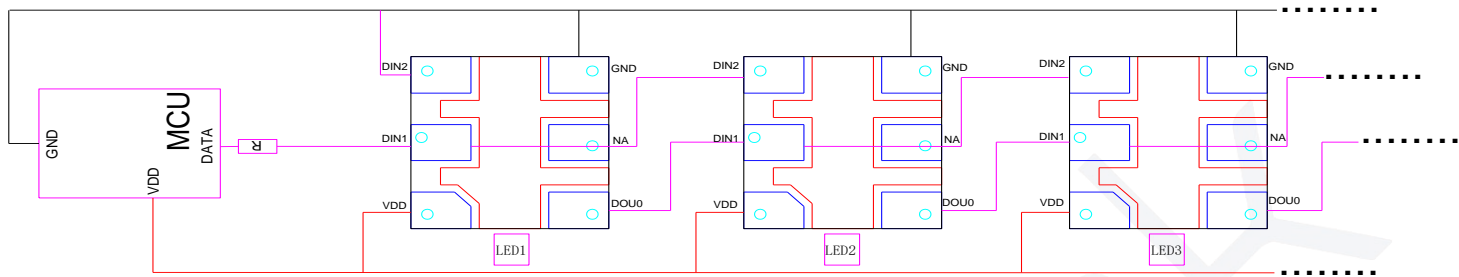

1. Typical application circuit

Notes:

When the first LED is connected to the MCU, a resistor R needs to be connected in series between its signal input line and the MCU. The size of R depends on the number of cascaded beads. The more cascades, the less resistance R is used. Generally, the recommended setting is between 100 and 1K. The recommended value is usually around 300r. In order to make the LED work more stable, a parallel capacitor between the VDD and GND of the first LED is required.

2. Precautions for Use

2.1. Over-current-proof

Customer must apply resistors for protection; otherwise slight voltage shift will cause big current change (Burn-out will happen).

2.2. Storage

1). To store the products is recommended with following conditions:

Humidity: 60% R.H. Max. Temperature: 5°C~30°C (41°F~86°F)

2). Shelf life in sealed bag: 12 months at <math>< 5^{\circ}\text{C} \sim 30^{\circ}\text{C}</math> and <math>< 60\% \text{ R.H.}</math> after the package is Opened, the products should be used within 72 hours or they should be stored at $\leq 20\% \text{ R.H.}$ with zip-lock sealed bag.

2.3. Baking

The products are not used up within 72 hours, and please bake them before using:

1). 60±3°C X 6hrs and <math>< 5\% \text{ RH}</math>, for reel

2). 125±3°C X 2hrs, for single LED

It is normal to see slight color fading of carrier (light yellow) after baking in process.

C31212VGBCH04

Tapping

1. Dimensions of Tape (Unit: mm)

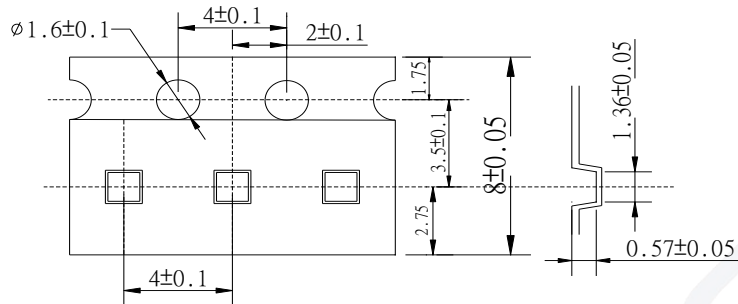

2. Arrangement of Tape

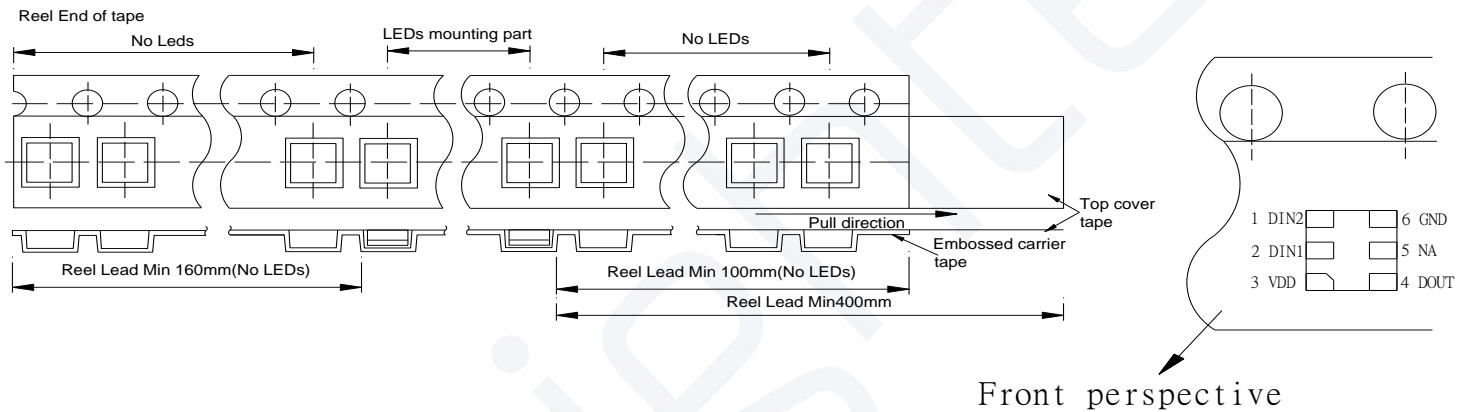

3. Dimensions of Reel (Unit: mm)

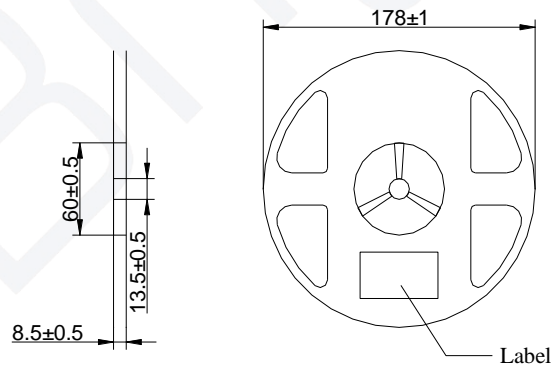

Notes:

1. Empty component pockets are sealed with top cover tape
2. The max loss number of SMD is 2pcs
3. The cathode is oriented towards the tape sprocket hole in accordance with ANSI/EIA RS-481 specifications
4. 4,000pcs per reel
5. The remainder packing in multiples of 500pcs.

Packing

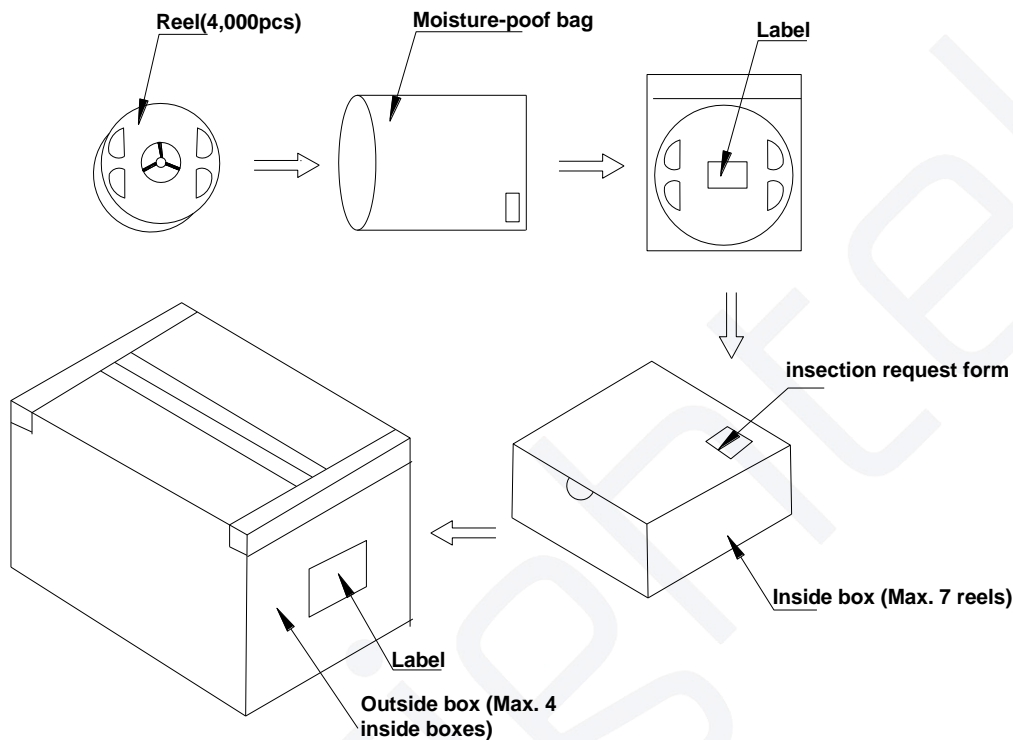

Reeled product (max.4,000) is packed in a sealed moisture-proof bag. Seven bags are packed in an inner box (size: about 260 X 230 X 100 mm) and four inner boxes are in an outer box (size: about 480 X 275 X 215 mm). On the label of moisture-proof bag, there should be the information of Part No., Lot No. and quantity number; also the total quantity number should be on inspection request form on outer box.

Precautions

1. Abnormal situation caused by improper setting of collet

To choose the right collet is the key issue in improving the product's quality. LED is different from other electronic components, which is not only about electrical output but also for optical output. This characteristic made LED more fragile in the process of SMT. If the collet's lowering down height is not well set, it will bring damage to the gold wire at the time of collet's picking up and loading which will cause the LED fail to light up, light up now and then or other quality problems.

2. How to choose the collet

During SMT, please choose the collet that has larger outer diameter than the lighting area of lens, in case that improper position of collet will damage the gold wire inside the LED. Different collets fit for different products, please refer to the following pictures cross out.

Outer diameter of collet should be larger than the lighting area

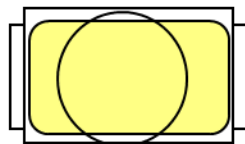

Picture 1 (✓)

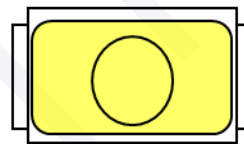

Picture 2 (X)

3. Other points for attention

- No pressure should be exerted to the epoxy shell of the SMD under high temperature.
- Do not scratch or wipe the lens since the lens and gold wire inside are rather fragile and cross out easy to break.
- CLED should be used as soon as possible when being taken out of the original package, and should be stored in anti-moisture and anti-ESD package.

4. This usage and handling instruction is only for your reference.

Disclaimer

1. Brightek reserves the right(s) on the adjustment of product material mix for the specification.
2. The product meets Brightek published specification for a period of one year from date of shipment.
3. The graphs shown in this datasheet are representing typical data only and do not show guaranteed values.
4. When using this product, please observe the absolute maximum ratings.
5. instructions for using outlined in these specification sheets. Brightek assumes no responsibility for any damage resulting from the use of the product which does not comply with the absolute maximum ratings and the instructions included in these specification sheets.
6. These specification sheets include materials protected under copyright of Brightek. Reproduction in any form is prohibited without obtaining Brightek's prior consent.
7. This product is not intended to be used for military, aircraft, life sustaining or life saving applications or any other application which can result in human injury or death. Please contact authorized Brightek sales agent for special application request.