

# 1SA0603B12E0BFZ1

- ◆ Outline(L\*W\*H): 1.6\*0.9\*0.75mm
- ◆ Good thermal dissipation & optical uniformity

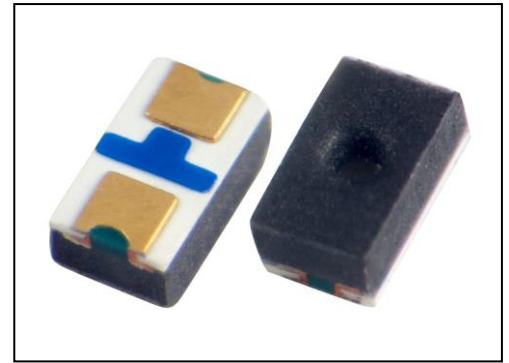

## Table of Contents

Product Code Method -----	2
Maximum Rating-----	2
Typical Product Characteristics-----	3
Range of Bins-----	3
Electronic-optical Characteristics-----	4
Dimensions-----	5
Reflow Profile-----	6
Test Circuit and Handling Precautions-----	7
Packing-----	8
Precautions-----	10
Test Items and Results of Reliability-----	11

## Features

- Forward current:  $\leq 30\text{mA}$
- Typical view angle 50% I<sub>v</sub>: 50°
- RoHS2.0 and REACH-compliant
- Lens color: black
- Qualified according to JEDEC moisturevity Level 2a
- ESD level 6kV(HBM)

## Applications

- Indoor signage display applications
- Flat backlight for LCD. Switch and symbol
- Indicator and backlighting for all consumer electronics
- Special application

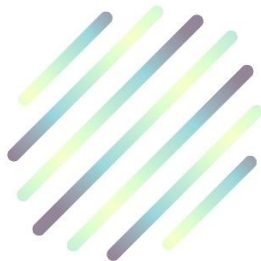

**Product Code Method**
**1 - S - A - 0603 - B12E - 0 - B - F - Z1**

①   ②   ③   ④   ⑤   ⑥   ⑦   ⑧   ⑨

①	②	③	④	⑤
Process Type	Category	LED Type	Lead Frame Size	Dice wavelength & luminous rank
1: normal process	S: SMD LED	A: PCB top view B: PCB side view	0603: 1.6*0.9mm	Bxxx: blue

⑥	⑦	⑧	⑨
Lap Polarity	Cap Color	PCB Module Code	Flow Code
0: non-common anode and non-common cathode	B: black	F: article mode	Z: zener 1: no expression above meaning for company

**Maximum Rating(Ta=25°C)**

Characteristics	Symbol	Rating	Unit
DC forward current	I <sub>F</sub>	30	mA
Pulse forward current <sup>*3</sup>	I <sub>PF</sub>	100	mA
Reverse voltage	V <sub>R</sub>	5	V
Junction temperature	T <sub>J</sub>	110	°C
Operating temperature range	T <sub>OP</sub>	-40-85	°C
Storage temperature range	T <sub>STG</sub>	-40-100	°C
Soldering temperature <sup>*4</sup>	T <sub>SD</sub>	260	°C

Notes 1: There is no maximum or typical voltage parameter

2: For other ambient, limited setting of current will be depended on de-rating curves.

3: Duty 1/10, pulse width 0.1ms

 4: The maximum of soldering time is 5 seconds in T<sub>SD</sub>

**Typical Product Characteristics (Ta=25°C)**

Characteristics	Symbol	Min.	Typ.	Max.	Unit	Test condition
Forward Voltage	$V_F$	2.5	3.0	3.4	V	$I_F=5mA$
Reverse Current	$I_R$	-	-	10	$\mu A$	$V_R= 5V$
Luminous Intensity	$I_v$	5	15	-	mcd	$I_F=5mA$
View Angle	$2\theta_{1/2}$	-	50	-	deg	$I_F=5mA$
Dominant Wavelength	$\lambda_d$	462.5	-	472.5	nm	$I_F=5mA$

Notes: 1. Measurement Errors:

Forward Voltage:  $\pm 0.1V$ , Luminous Intensity:  $\pm 10\%I_v$ , View Angle ( $2\theta_{1/2}$ ):  $\pm 5\%$ , Dominant Wavelength( $\lambda_d$ ):  $\pm 1.0nm$

2. Electrical-Optical characteristics (Ta=25°C)

**Range of Bins**
**1). Forward Voltage Bins ( $I_F=5mA$ )**

Bin Code	Min.(V)	Max. (V)
e	2.5	2.8
f	2.8	3.1
g	3.1	3.4

**2). Luminous Lumen Bins ( $I_F=5mA$ )**

Bin Code	Min. (mcd)	Max. (mcd)
8	5	8
9	8	12.5
A	12.5	16
B	16	20
C	20	25

**3). Dominant Wavelength Bins ( $I_F=5mA$ )**

Bin Code	Min. (nm)	Max. (nm)
F	462.5	465
G	465	467.5
H	467.5	470
I	470	472.5

Electrical-Optical Characteristics

1).Relative Spectral Distribution

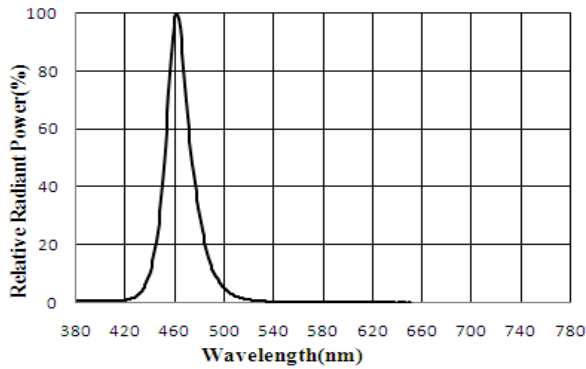

2).Typical Spatial Distribution

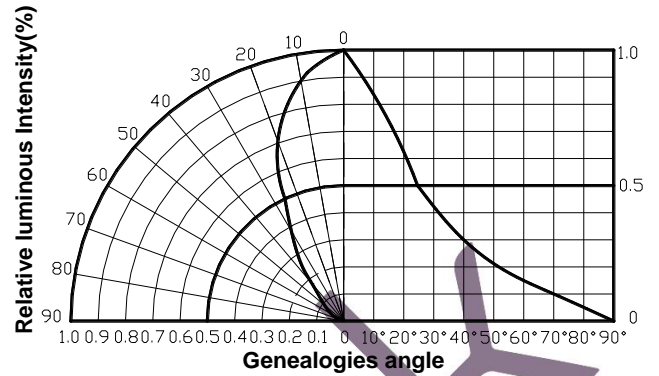

3).Relative Luminous Flux .Current

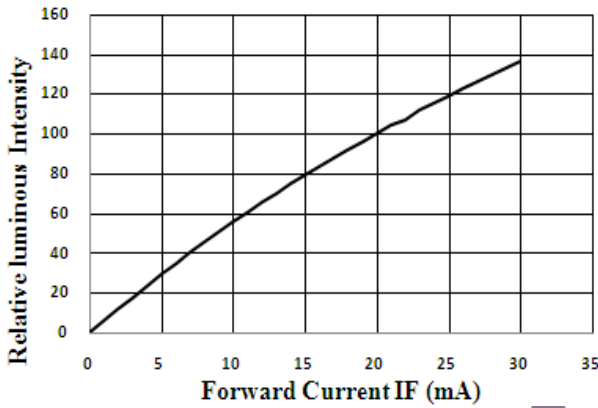

4).Relative Luminous Flux .Ambient Temperature

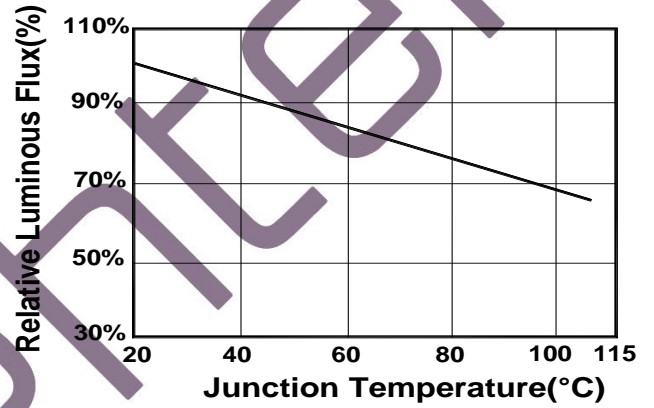

5).Electrical Characteristics

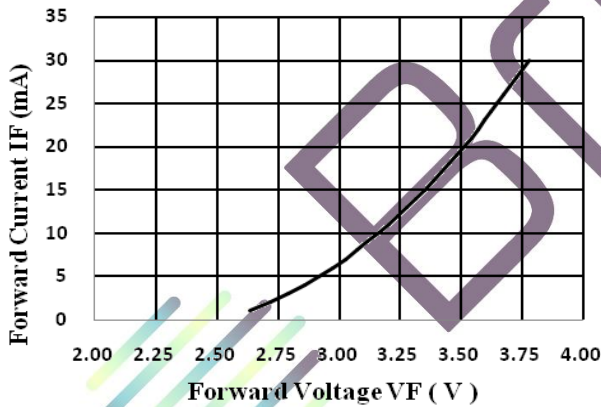

6).Forward Voltage Temperature

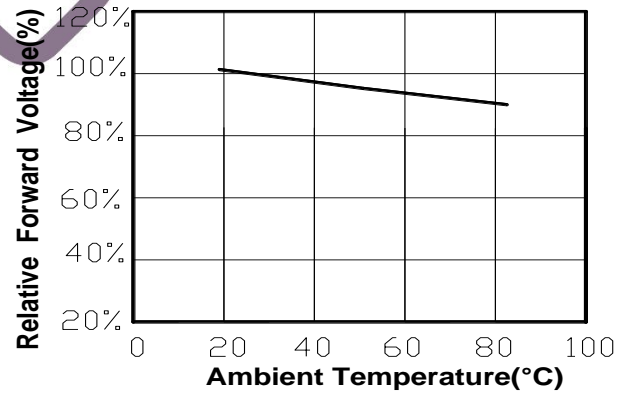

7).Relative Emission Efficiency. Current

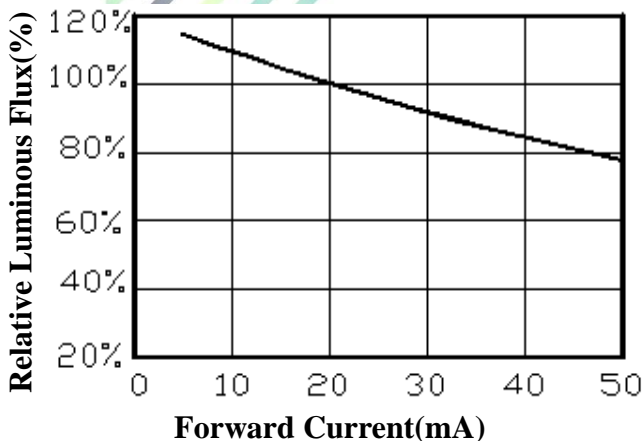

8).Thermal Design

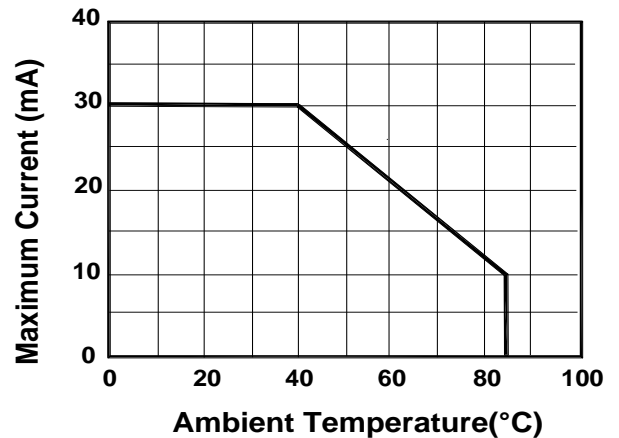

**■ Dimensions**

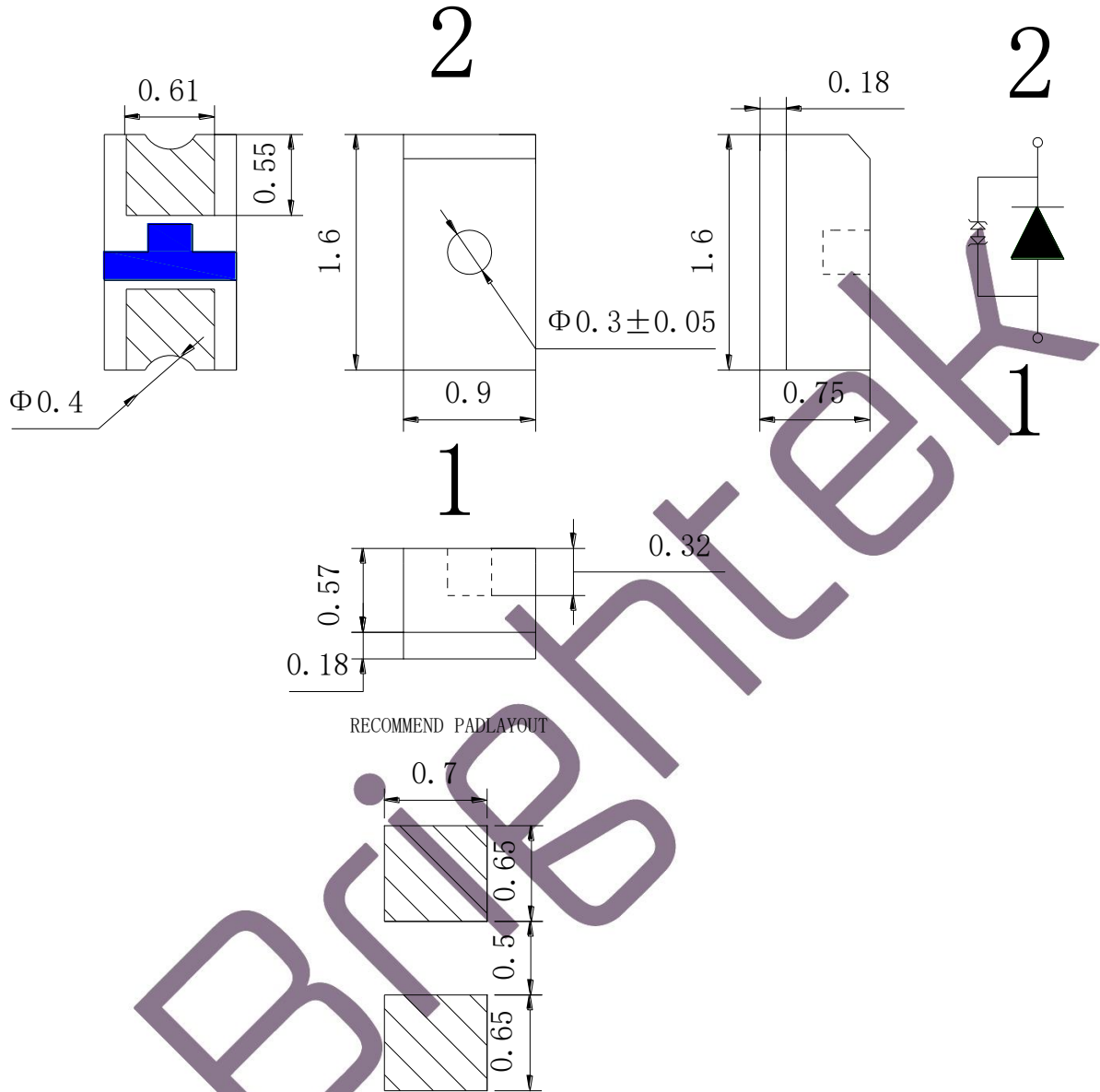

---



- Notes:
1. All dimensions are in millimeters
  2. Tolerance is  $\pm 0.1$  mm unless otherwise noted
  3. Specifications are subject to change without notice.

■ **Reflow Profile**

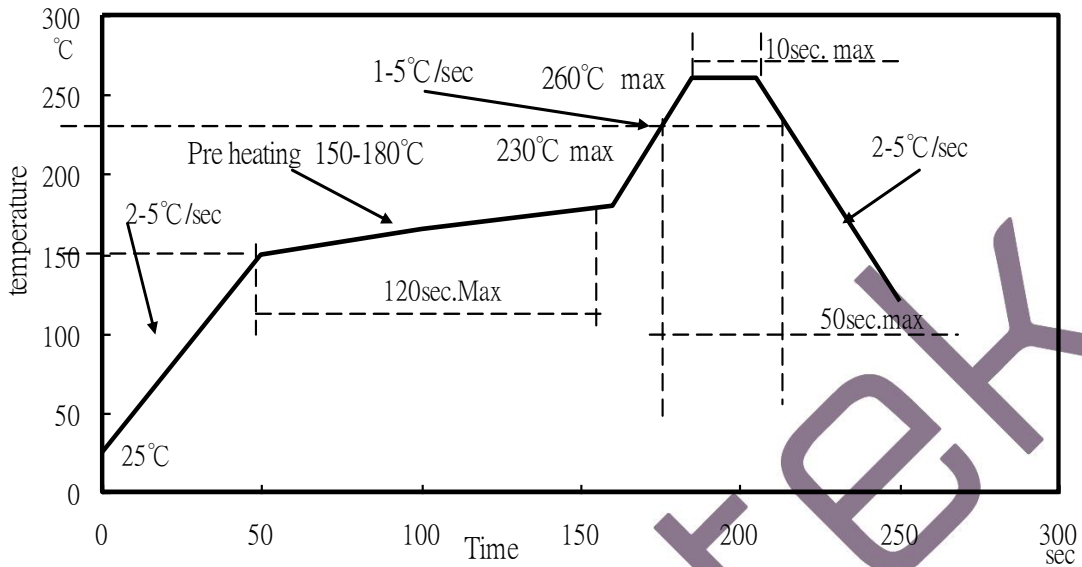
**1. IR reflow soldering Profile for Lead Free solder**



**2. IR reflow soldering Profile for Lead solder**

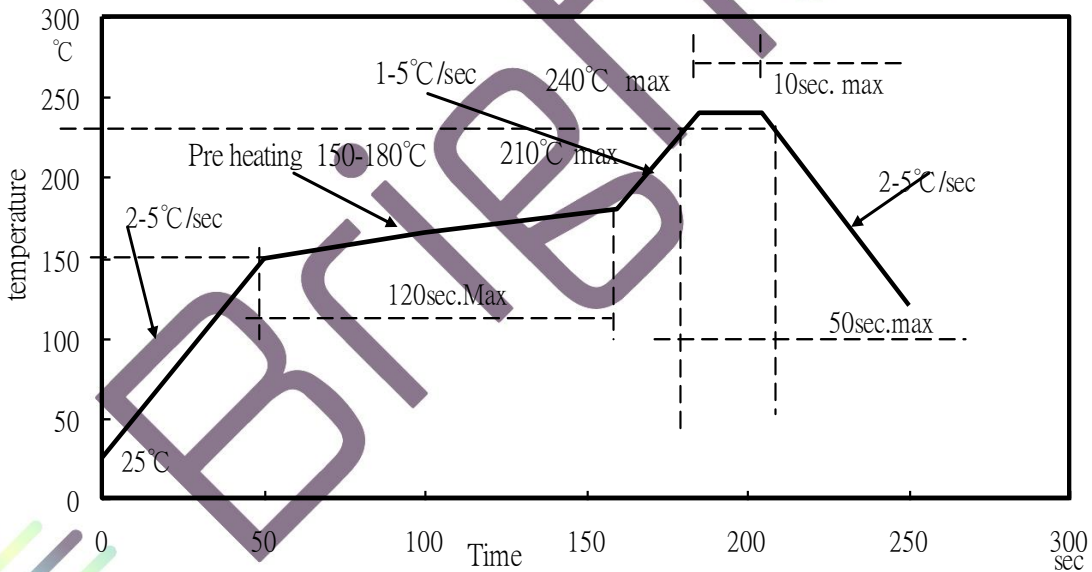

**Notes:**

1. We recommend the reflow temperature 240°C (±5°C).the maximum soldering temperature should be limited to 260°C.
2. Don't cause stress to the silicone resin while it is exposed to high temperature.
3. Number of reflow process shall be less than 3 times.

**■ Test Circuit and Handling Precautions**

---

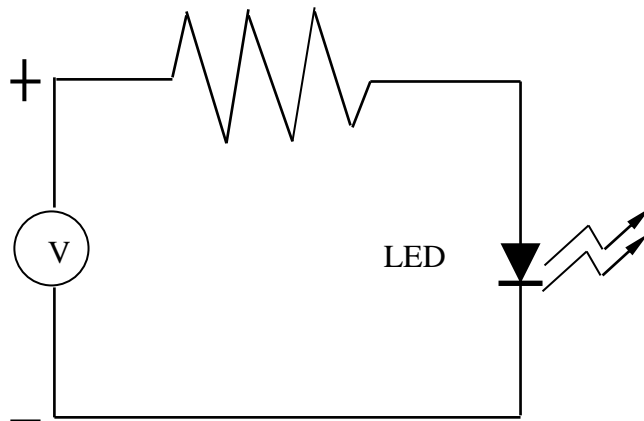
**1. Test circuit**

**2. Handling precautions**
**2.1. Over-current-proof**

Customer must apply resistors for protection; otherwise slight voltage shift will cause big current change (Burn out will happen).

**2.2. Storage**

1). It is recommended to store the products in the following conditions:

Humidity: 60% R.H. Max.

Temperature: 5°C~30°C (41°F~86°F)

2). Shelf life in sealed bag: 12 month at <5°C~30°C and <60% R.H. after the package is Opened, the products should be used within a week or they should be keeping to stored at  $\leq 20\%$ R.H. with zip-lock sealed.

**2.3. Baking**

It is recommended to baking before soldering when the pack is unsealed after 24hrs.

The Conditions are as followings:

1). 60±3°C X 24hrs and <5%RH, for reel

2). 125±3°C X 2hrs, for single LED

It shall be normal to see slight color fading of carrier (light yellow) after baking in process

■ Packing

● Feeding Direction (Unit: mm)

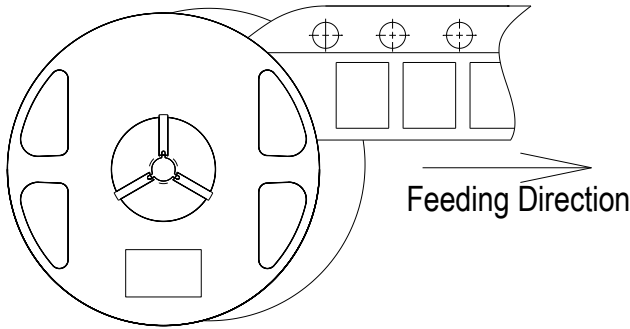

● Dimensions of Reel (Unit: mm)

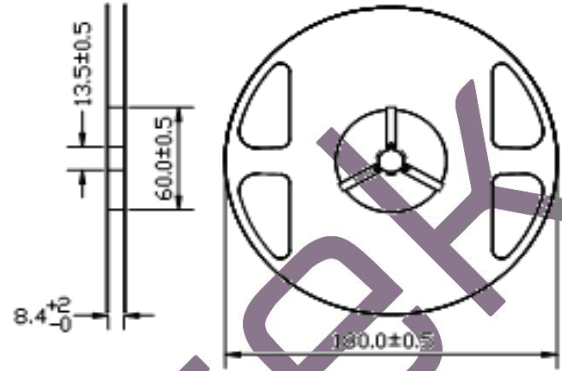

● Dimensions of Tape (Unit: mm)

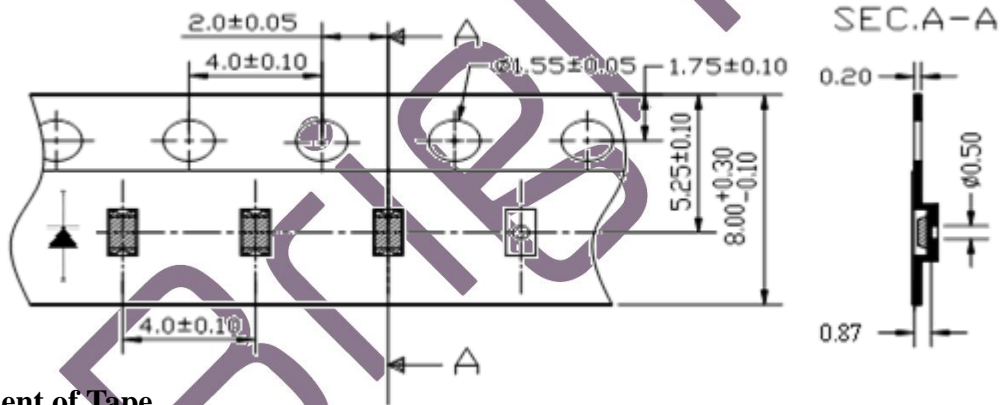

● Arrangement of Tape

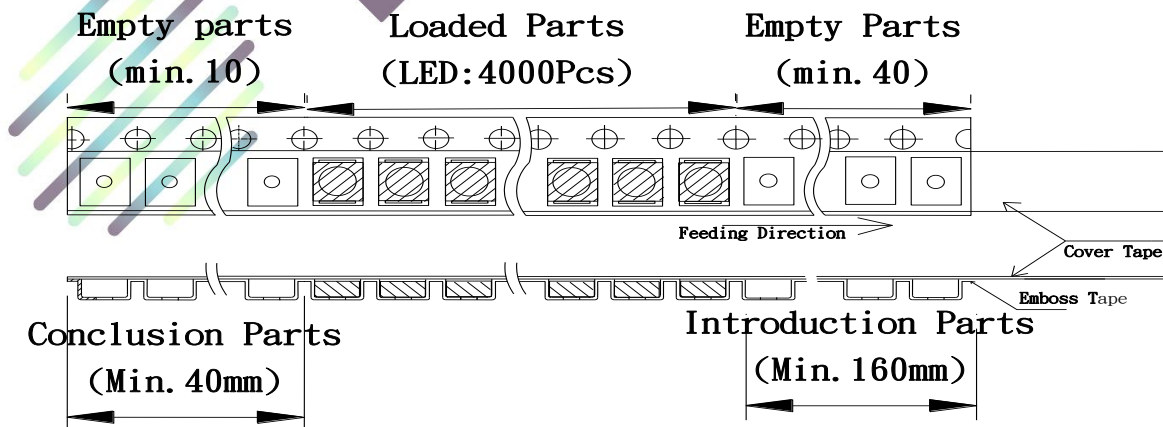

Notes:

1. Empty component pockets are sealed with top cover tape
2. The max loss number of SMD is 2pcs
3. The cathode is oriented towards the tape sprocket hole in accordance with ANSI/EIA RS-481



■ Packing

● Packaging specifications

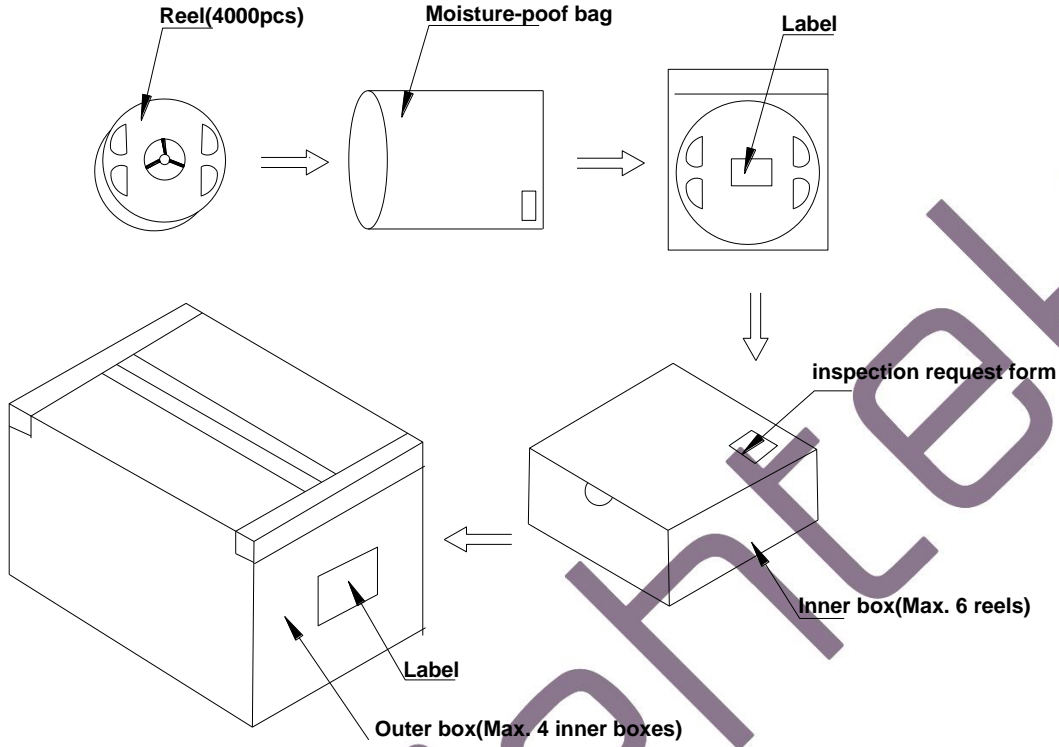

**Notes:**

Reeled product (max.4,000) is packed in a sealed moisture-proof bag. Six bags are packed in an inner box (size: about 260 X 230 X 100 mm) and four inner boxes are in an outer box (size: about 480 X 275 X 215 mm). On the label of moisture-pooof bag, there should be the information of Part No., Lot No. and quantity number; also the total quantity number should be on inspection request form on outer box.



**■ Precautions**

---

**1. Abnormal situation caused by improper setting of collet**

To choose the right collet is the key issue in improving the product's quality. LED is different from other electronic components, which is not only about electrical output but also for optical output. This characteristic made LED more fragile in the process of SMT. If the collet's lowering down height is not well set, it will bring damage to the gold wire at the time of collet's picking up and loading which will cause the LED fail to light up, light up now and then or other quality problems

**2. How to choose the collet**

During SMT, please choose the collet that has larger outer diameter than the lighting area of lens, in case that improper position of collet will damage the gold wire inside the LED. Different collets fit for different products, please refer to the following pictures cross out

**Outer diameter of collet should be larger than the lighting area**

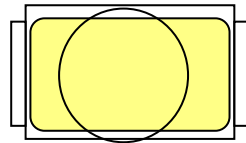

**Picture 1(√)**

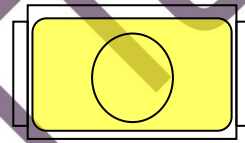

**Picture 2(X)**

**3. Other points for attention**

- A. No pressure should be exerted to the epoxy shell of the SMD under high temperature.
- B. Do not scratch or wipe the lens since the lens and gold wire inside are rather fragile and cross out easy to break.
- C. LED should be used as soon as possible when being taken out of the original package, and should be stored in anti-moisture and anti-ESD package.

**4. This usage and handling instruction is only for your reference.**

**■ Test Items and Results of Reliability**

Test Item	Test Conditions	Duration/ Cycle	Ac/Re	Number of Damage	Reference
Normal Temperature Life	Ta=23°C (±5°C) IF=20mA	1008 hrs	0/1	0/22	JESD22 A-108
High Temperature Life	Ta=85°C (±5°C) IF=20mA	1008 hrs	0/1	0/22	JESD22 A-108
High Humidity Heat Life	Ta=85°C (±5°C) RH=85% IF=20mA	1008 hrs	0/1	0/22	JESD22 A-108
Thermal shock	-45°C/30min~105°C /30min (±5°C)	1008 hrs	0/1	0/22	JESD22 A-104
Electrostatic Discharge (ESD) Test	According to the SPEC	3 cycles	0/1	0/22	AEC Q101-001
Low Temperature Storage	Ta=-40°C	1008 hrs	0/1	0/22	JESD22-A103D
High Temperature Storage	Ta=125°C	1008 hrs	0/1	0/22	JESD22-A103D

<b>*Criteria for Judging</b>				
Item	Symbol	Condition	Criteria for Judgment of Pass	
			Min	Max
Forward Voltage	V <sub>F</sub>	I <sub>F</sub> =5mA	-	USL* <sup>1</sup> ×1.1
Reverse Current	I <sub>R</sub>	V <sub>R</sub> = 5V	-	10μA
Luminous Intensity	I <sub>V</sub>	I <sub>F</sub> =5mA	LSL* <sup>2</sup> ×0.7	-

[Note] USL\*<sup>1</sup>: Upper Specification Level

LSL\*<sup>2</sup>: Lower Specification Level

