

HE1616F85CQ01 Datasheet

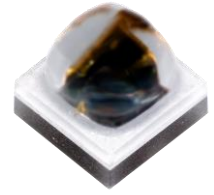

Infrared Emitter

1616 Series (850nm) - 80°



Applications

- Security System
- Automotive
- Facial Recognition
- Gesture Recognition

Features

- Package: clear silicone
- Low thermal resistance (Max. 12 K/W)
- Corrosion robustness class : A
- Peak wavelength 850 nm
- ESD: 2KV (HBM)
- Optimized for high current pulse operation
- IR light source with high efficiency
- RoHS 2.0 and REACH compliant
- Dual junction emitter
- MSL 1 qualified according to J-STD 020
- Qualifications: AEC-Q102 Qualified

HE1616F85CQ01

Dimensional Drawing

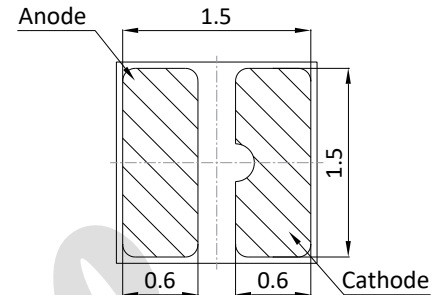
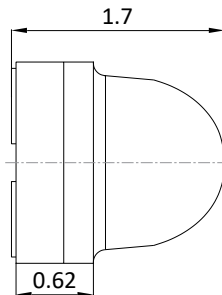
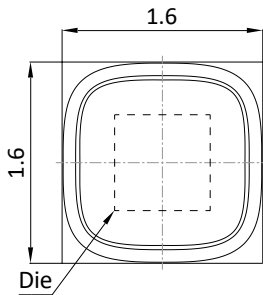

1. Dimensions are in millimeters.
2. General tolerance is $\pm 0.05\text{mm}$.
3. Lead finish Au.

Recommended Solder Pad

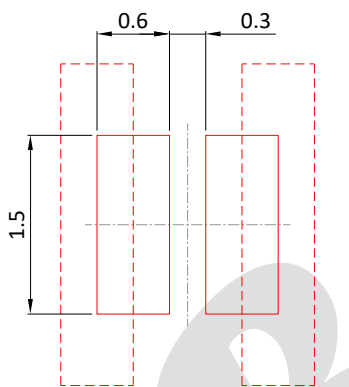

□ foot print □ Cu area

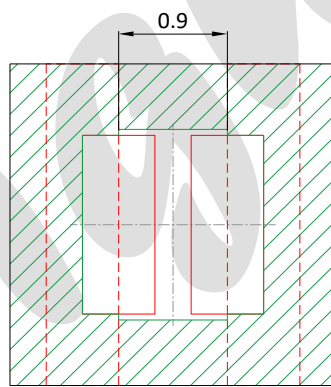

▨ solder resist

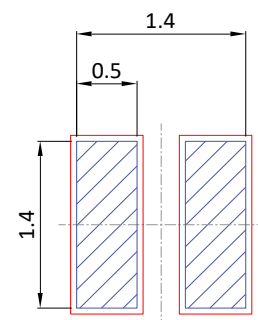

▨ solder stencil
recommended stencil

HE1616F85CQ01

Maximum Ratings

T_A : 25 °C

Parameter	Symbol	Rating
Forward current	I _F	max. 1000 mA
Power consumption	P _{tot}	max. 3.6 W
Pulse forward current	I _{PF}	max. 2 A
Reverse voltage	V _R	max. 5 V
Junction temperature	T _j	max. 145 °C
Operating temperature	T _{op}	min. -40 °C
		max. 105 °C
Storage temperature	T _{stg}	min. -40 °C
		max. 105 °C
Soldering temperature	T _{sol}	max. 260 °C
Thermal resistance junction	R _{th}	typ. 9 K/W
		max. 12 K/W
ESD withstand voltage (HBM : MIL STD 883 Class 2)	V _{ESD}	max. 2 kV

1. For other ambient, limited setting of current will depend on de-rating curves.
2. When drive on maximum current, Junction temperature must be kept below 145°C.

HE1616F85CQ01

Characteristics

I_F : 1A | t_p : 10 ms | T_A : 25°C

Parameter	Symbol	Values
Peak wavelength	λ_p	typ. 850 nm
Spectral bandwidth	$\Delta\lambda$	typ. 40 nm
View angle	$2\theta_{1/2}$	typ. 80 °
Total radiant power $I_F = 1\text{ A}; t_p = 100\ \mu\text{s}$	Φ_e	min. 1200 mW typ. 1400 mW max. 1600 mW
Radiant intensity $I_F = 1\text{ A}; t_p = 100\ \mu\text{s}$	I_E	min. 650 mW/sr typ. 750 mW/sr max. 850 mW/sr
Forward voltage $I_F = 1\text{ A}; t_p = 100\ \mu\text{s}$	V_F	min. 2.9 V typ. 3.3 V max. 3.6 V
Reverse current ($V_R=5\text{V}$)	I_R	max. 10 μA

HE1616F85CQ01

Brightness Groups

Total radiant power $I_F : 1A$ | $t_p : 10$ ms

Group	min. Φ_e	max. Φ_e
PB2A	1200 mW	1400 mW
PB4A	1400 mW	1600 mW

Forward voltage $I_F : 1A$ | $t_p : 10$ ms

Group	min. V_F	max. V_F
LP	2.9 V	3.6 V

Peak wavelength $I_F : 1A$ | $t_p : 10$ ms

Group	min. λ_p	max. λ_p
F3	840 nm	870 nm

HE1616F85CQ01

Typical Electrical Optical Characteristics Curves

Radiation Characteristics

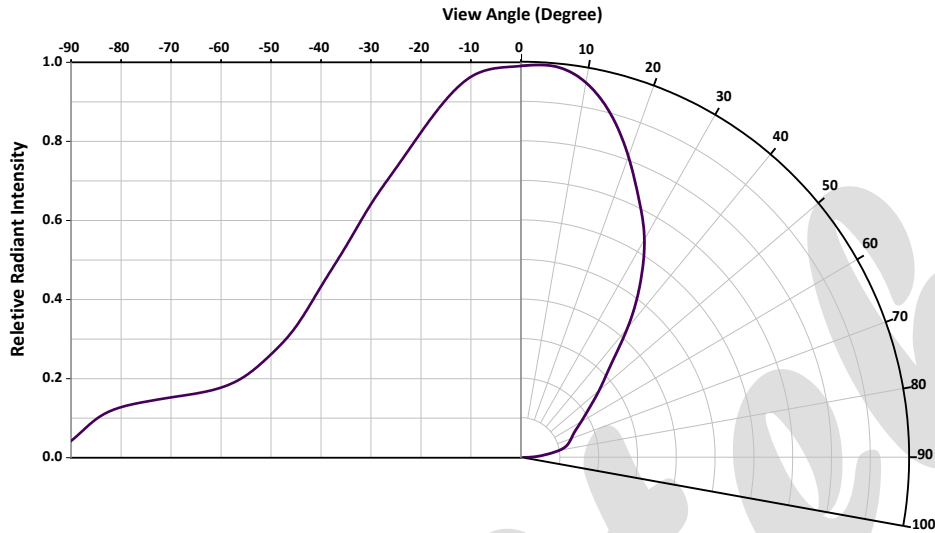

Radiant Intensity

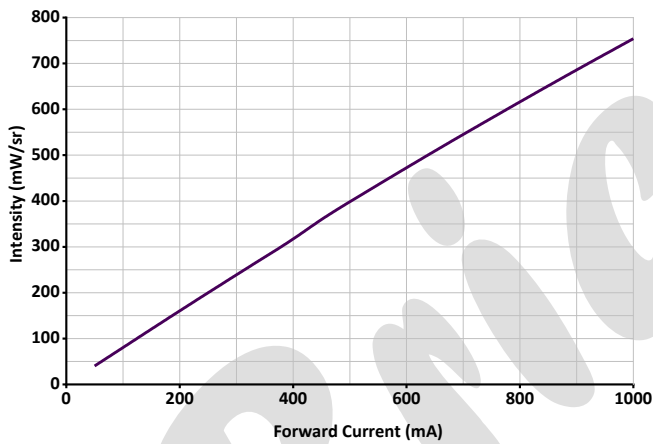

Total radiant power

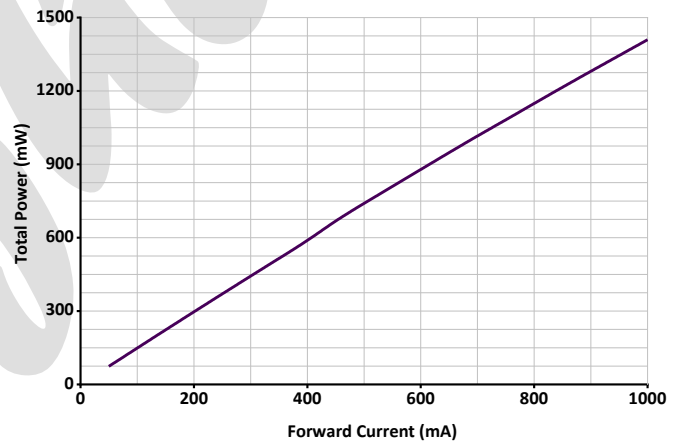

Forward Voltage

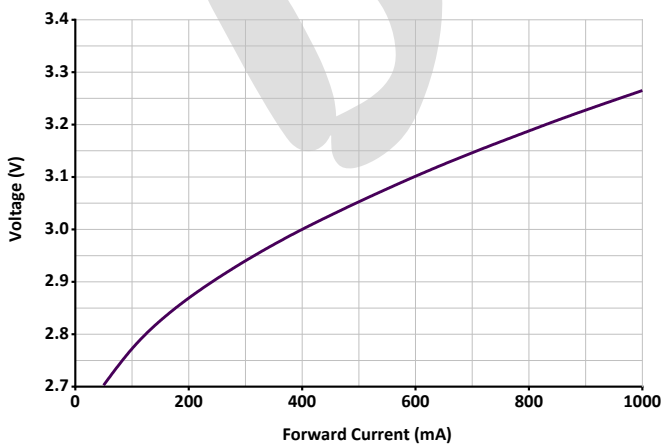

Relative Spectral Emission

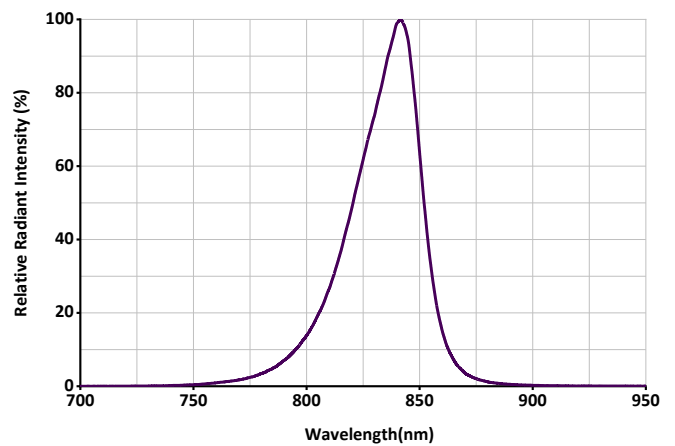

HE1616F85CQ01

Permissible Forward Current

$$I_{F,max} = f(T_S); R_{th_{j_s}} = 12 \text{ K/W}$$

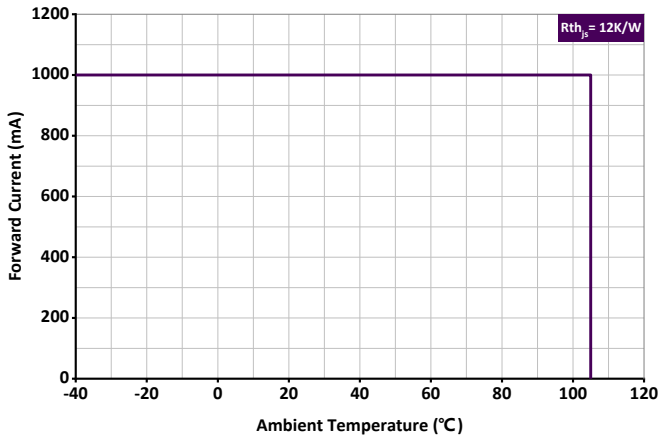

Permissible Pulse Handling Capability

$$I_F = f(t_p); D = \text{Duty cycle}; T_a \text{ max} = 85^\circ\text{C}$$

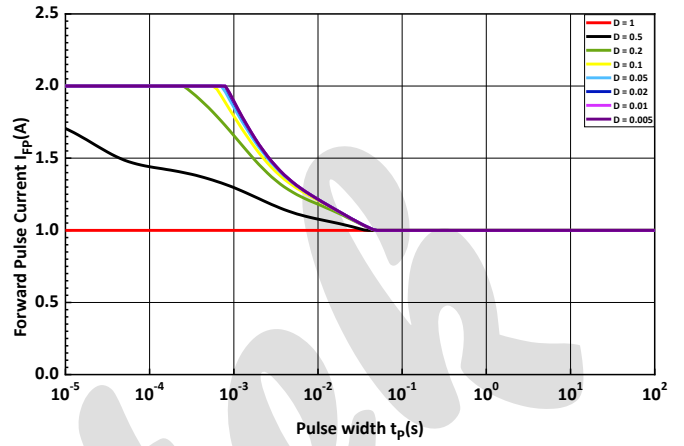

HE1616F85CQ01

Reflow Soldering Profile

Product complies to MSL Level 1 acc. to JEDEC J-STD-020E

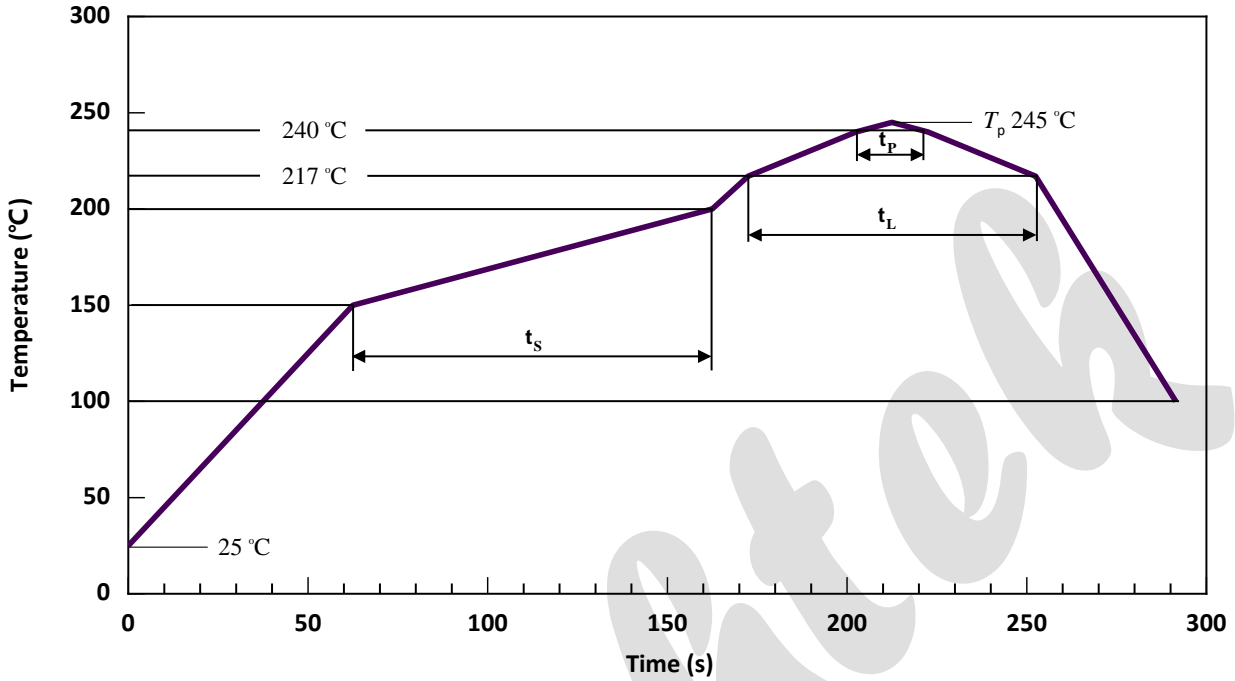

Profile Feature	Symbol	Pb-Free (SnAgCu) Assembly			Unit
		Minimum	Recommendation	Maximum	
Ramp-up rate to preheat 25 °C to 150 °C			2	3	K/s
Time t_s T_{Smin} to T_{Smax}	t_s	60	100	120	s
Ramp-up rate to peak T_{Smax} to T_P			2	3	K/s
Liquidus temperature	T_L		217		°C
Time above liquidus temperature	t_L		80	100	s
Peak temperature	T_P		245	260	°C
Time within 5 °C of the specified peak temperature $T_P - 5$ K	T_P	10	20	30	s
Ramp-down Rate T_P to 100 °C			3	4	K/s
Time 25 °C to T_P				480	s

1. Do not stress the silicone resin while it is exposed to high temperature.
2. The reflow process should not exceed 2 times.

HE1616F85CQ01

Dimensions of Tape

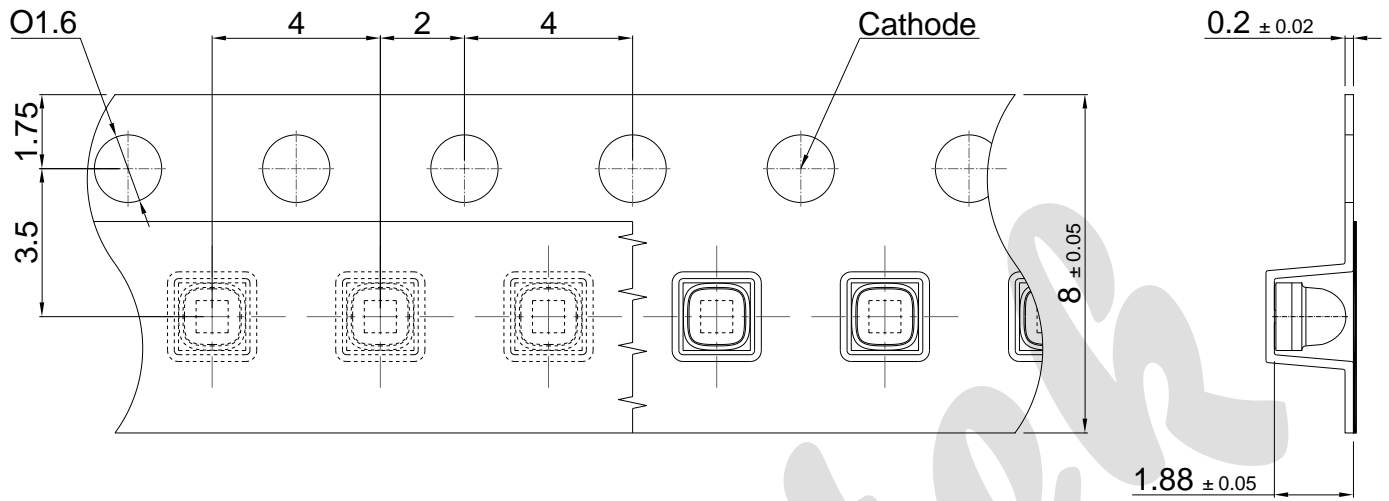

1. Dimensions are in millimeters.
2. General tolerance is $\pm 0.1\text{mm}$.

Dimensions of Reel

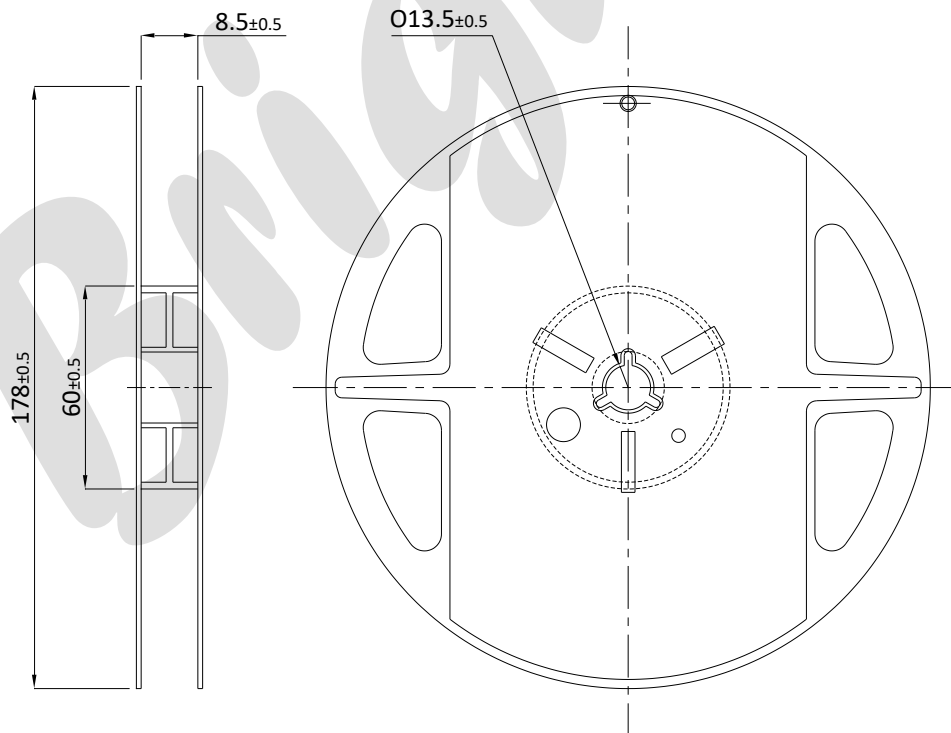

1. Dimensions are in millimeters.
2. 2000 pieces per reel.
3. Dimensions acc. to EIA 481-E

Disclaimer

1. Brightek reserves the right(s) on the adjustment of product material mix for the specification.
2. The product meets Brightek published specification for a period of one year from date of shipment.
3. The graphs shown in this datasheet are representing typical data only and do not show guaranteed values.
4. When using this product, please observe the absolute maximum ratings and the instructions for using outlined in these specification sheets. Brightek assumes no responsibility for any damage resulting from the use of the product which does not comply with the absolute maximum ratings and the instructions included in these specification sheets.
5. These specification sheets include materials protected under copyright of Brightek. Reproduction in any form is prohibited without obtaining Brightek's prior consent.
6. This product is not intended to be used for military, aircraft, life sustaining or life saving applications or any other application which can result in human injury or death. Please contact authorized Brightek sales agent for special application request.