

# HL1616F94CQ01 Datasheet

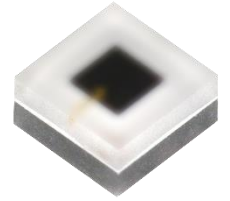

## Infrared Emitter

1616 Series (940nm) - 130°



### Applications

- Security System
- Automotive
- Facial Recognition
- Gesture Recognition

### Features

- Package: Clear silicone
- Low thermal resistance (Max. 12 K/W)
- Corrosion robustness class : A
- Peak wavelength 940 nm
- ESD: 2KV (HBM)
- Optimized for high current pulse operation
- IR light source with high efficiency
- RoHS 2.0 and REACH compliant
- Dual junction emitter
- MSL 1 qualified according to J-STD 020
- Qualifications: AEC-Q102 Qualified

# HL1616F94CQ01

## Dimensional Drawing

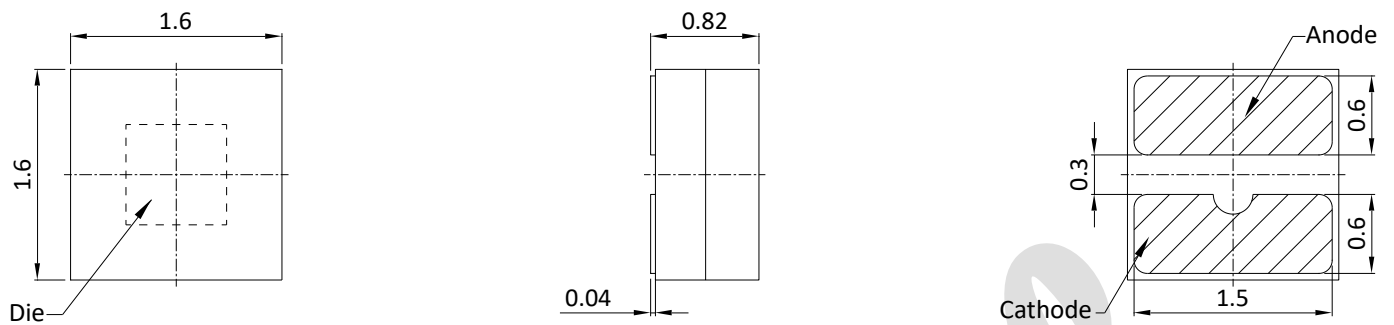

1. Dimensions are in millimeters.
2. General tolerance is  $\pm 0.05\text{mm}$ .
3. Lead finish Au.

## Recommended Solder Pad

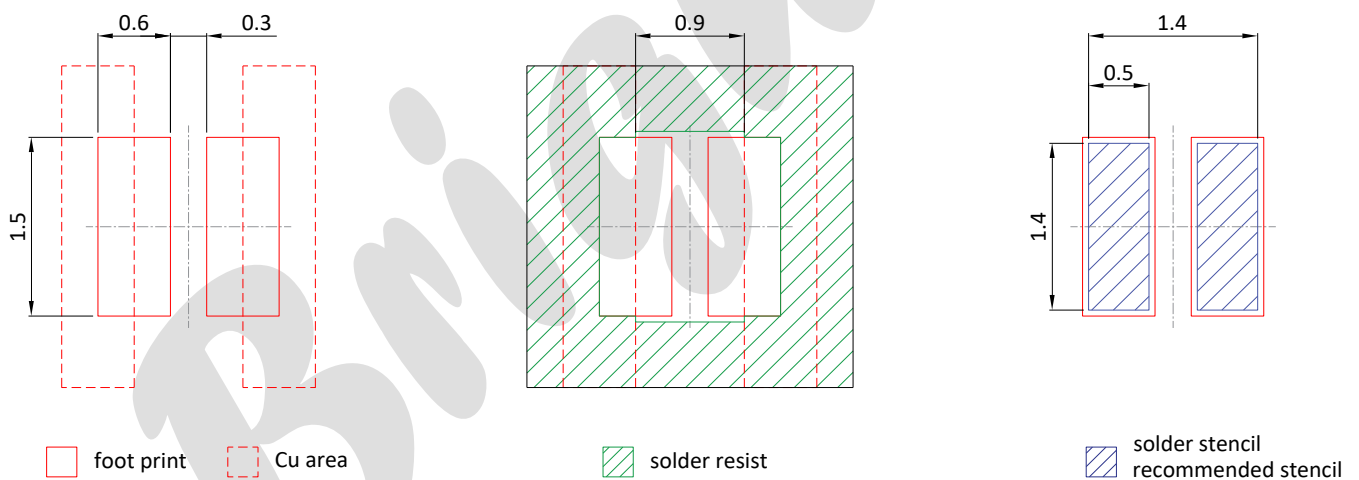

# HL1616F94CQ01

## Maximum Ratings

$T_A$  : 25 °C

Parameter	Symbol	Rating
Forward current	$I_F$	max. 1000 mA
Power consumption	$P_{tot}$	max. 3.6 W
Pulse forward current	$I_{PF}$	max. 2 A
Reverse voltage	$V_R$	max. 5 V
Junction temperature	$T_j$	max. 145 °C
Operating temperature	$T_{op}$	min. -40 °C
		max. 105 °C
Storage temperature	$T_{stg}$	min. -40 °C
		max. 105 °C
Soldering temperature	$T_{sol}$	max. 260 °C
Thermal resistance junction	$R_{th}$	typ. 9 K/W
		max. 12 K/W
ESD withstand voltage (HBM : MIL STD 883 Class 2)	$V_{ESD}$	max. 2 kV

1. For other ambient, limited setting of current will depend on de-rating curves.
2. When drive on maximum current, Junction temperature must be kept below 145°C.

# HL1616F94CQ01

## Characteristics

$I_F$ : 1A |  $t_p$ : 10 ms |  $T_A$ : 25°C

Parameter	Symbol	Values
Peak wavelength	$\lambda_p$	typ. 940 nm
Spectral bandwidth	$\Delta\lambda$	typ. 35 nm
View angle	$2\theta_{1/2}$	typ. 130 °
Total radiant power $I_F = 1\text{ A}; t_p = 100\ \mu\text{s}$	$\Phi_e$	min. 1000 mW typ. 1200 mW max. 1400 mW
Radiant intensity $I_F = 1\text{ A}; t_p = 100\ \mu\text{s}$	$I_E$	min. 300 mW/sr typ. 400 mW/sr max. 500 mW/sr
Forward voltage $I_F = 1\text{ A}; t_p = 100\ \mu\text{s}$	$V_F$	min. 2.8 V typ. 3.3 V max. 3.6 V
Reverse current ( $V_R=5\text{V}$ )	$I_R$	max. 10 $\mu\text{A}$

# HL1616F94CQ01

## Brightness Groups

Total radiant power  $I_F : 1A$  |  $t_p : 10$  ms

Group	min. $\Phi_e$	max. $\Phi_e$
PB0A	1000 mW	1200 mW
PB2A	1200 mW	1400 mW

Forward voltage  $I_F : 1A$  |  $t_p : 10$  ms

Group	min. $V_F$	max. $V_F$
KN	2.8 V	3.6 V

Peak wavelength  $I_F : 1A$  |  $t_p : 10$  ms

Group	min. $\lambda_p$	max. $\lambda_p$
F1	930 nm	950 nm

# HL1616F94CQ01

## Typical Electrical Optical Characteristics Curves

### Radiation Characteristics

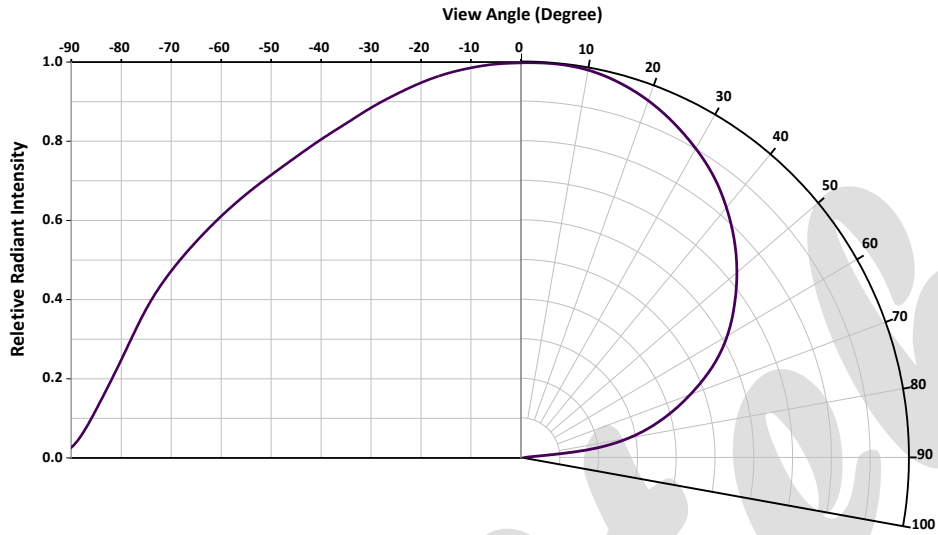

### Radiant Intensity

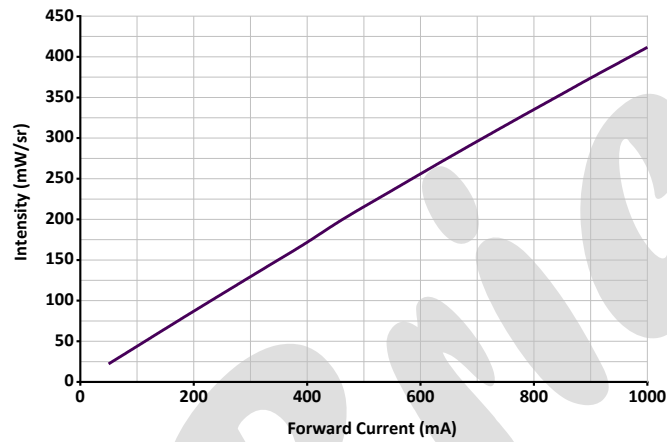

### Total radiant power

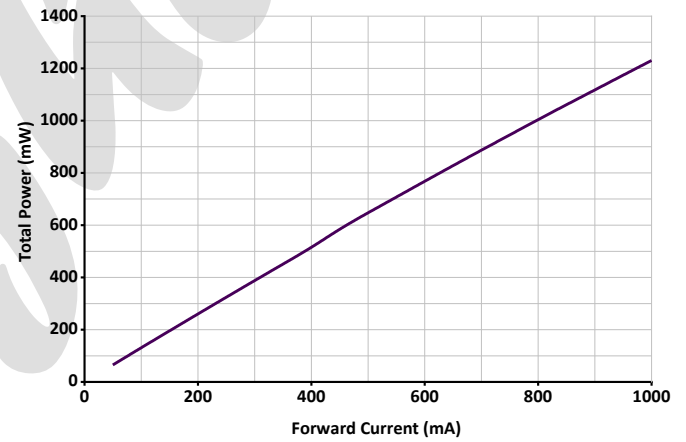

### Forward Voltage

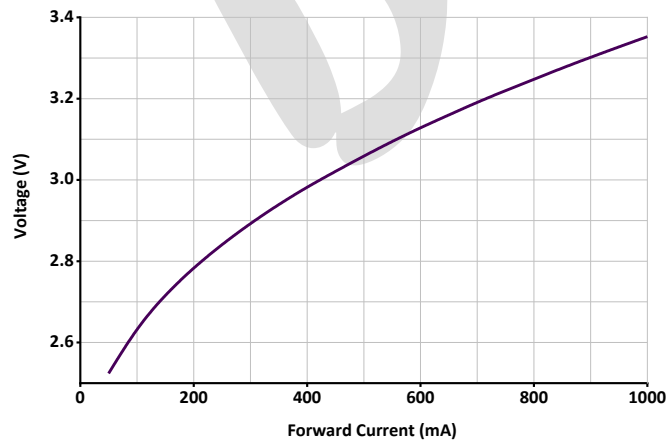

### Relative Spectral Emission

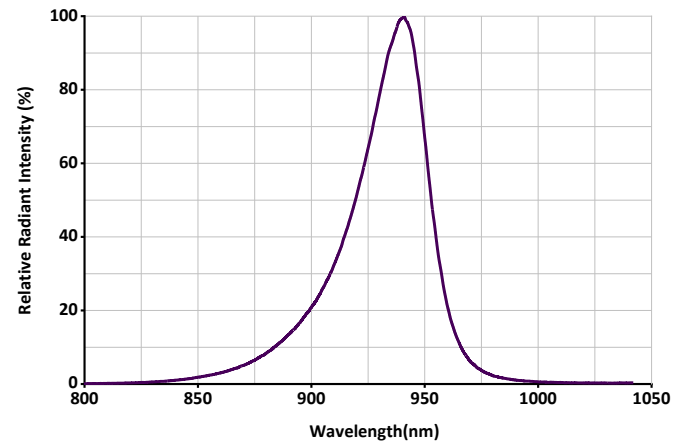

# HL1616F94CQ01

## Permissible Forward Current

$$I_{F,max} = f(T_s); R_{th_{j-s}} = 12 \text{ K/W}$$

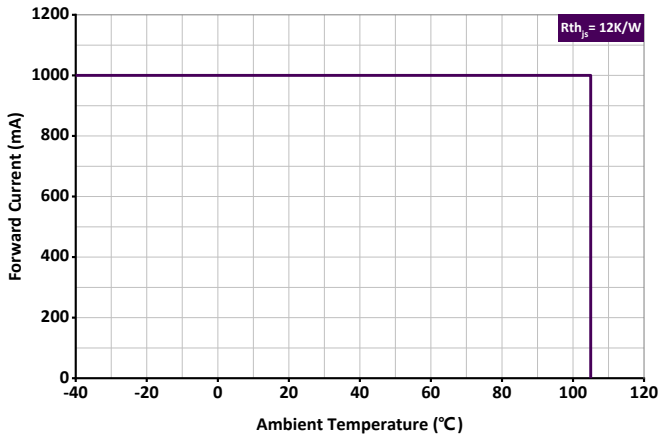

## Permissible Pulse Handling Capability

$$I_F = f(t_p); D = \text{Duty cycle}; T_a \text{ max} = 85^\circ\text{C}$$

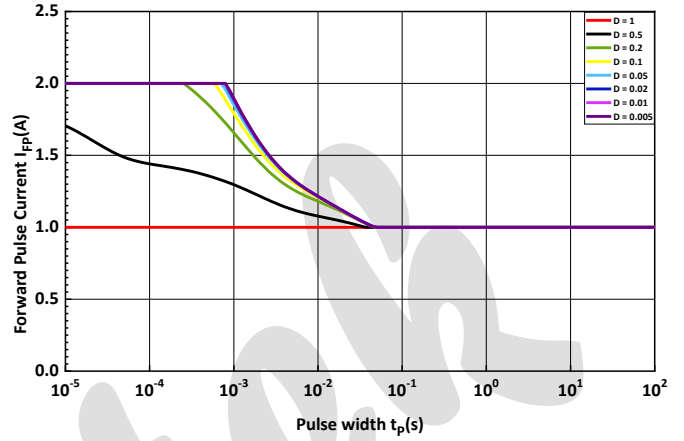

# HL1616F94CQ01

## Reflow Soldering Profile

Product complies to MSL Level 1 acc. to JEDEC J-STD-020E

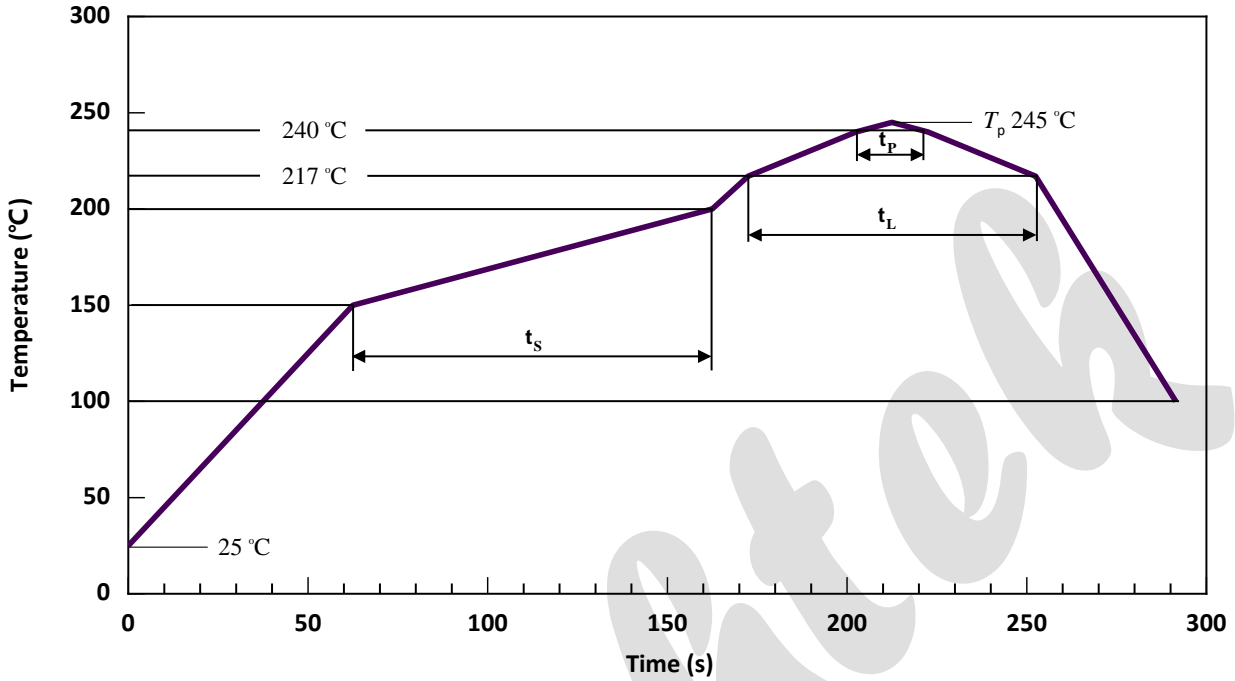

Profile Feature	Symbol	Pb-Free (SnAgCu) Assembly			Unit
		Minimum	Recommendation	Maximum	
Ramp-up rate to preheat 25 °C to 150 °C			2	3	K/s
Time $t_s$ $T_{Smin}$ to $T_{Smax}$	$t_s$	60	100	120	s
Ramp-up rate to peak $T_{Smax}$ to $T_P$			2	3	K/s
Liquidus temperature	$T_L$		217		°C
Time above liquidus temperature	$t_L$		80	100	s
Peak temperature	$T_P$		245	260	°C
Time within 5 °C of the specified peak temperature $T_P - 5$ K	$T_P$	10	20	30	s
Ramp-down Rate $T_P$ to 100 °C			3	4	K/s
Time 25 °C to $T_P$				480	s

1. Do not stress the silicone resin while it is exposed to high temperature.
2. The reflow process should not exceed 2 times.



# HL1616F94CQ01

## Dimensions of Tape

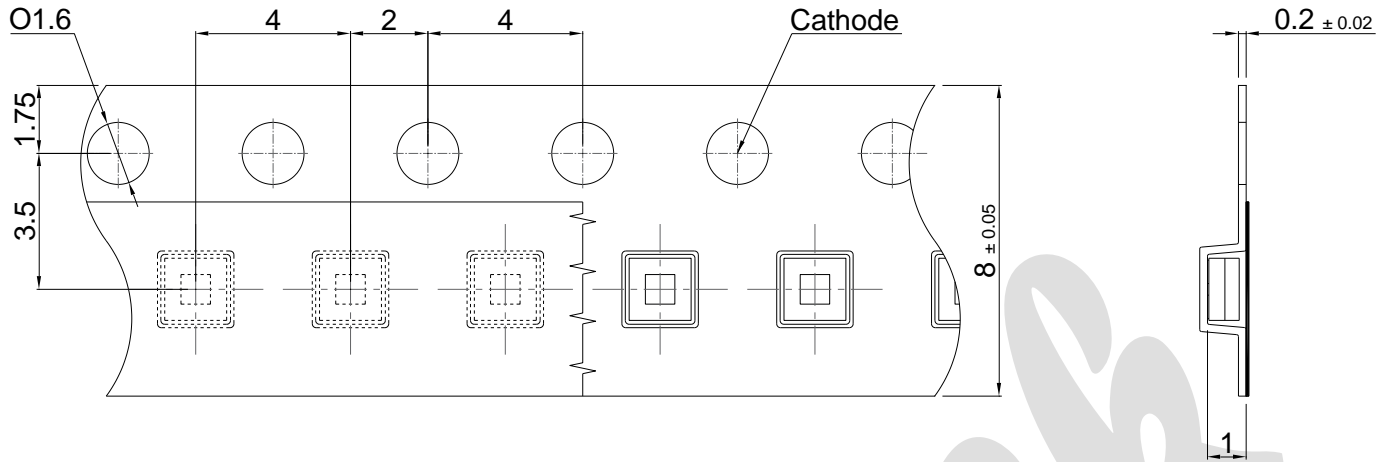

1. Dimensions are in millimeters.
2. General tolerance is  $\pm 0.1$ mm.

## Dimensions of Reel

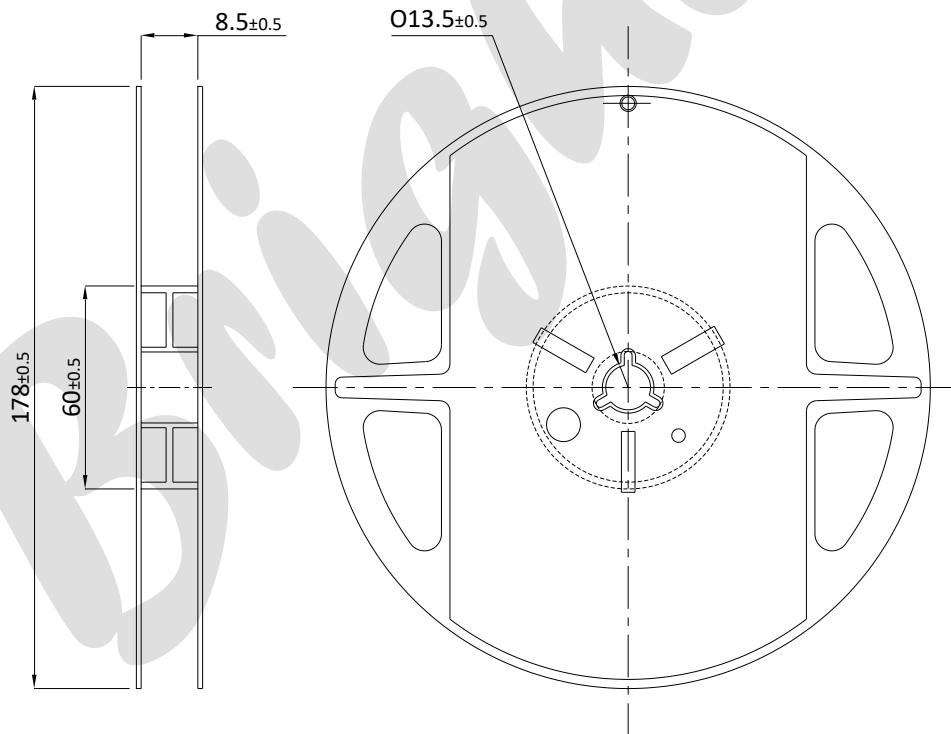

1. Dimensions are in millimeters.
2. 4000 pieces per reel.
3. Dimensions acc. to EIA 481-E

# HL1616F94CQ01

## Barcode-Product-Label (BPL)

		MSL
Part No:		
O Item:		
N Item:		
Q'TY:		
VF:	(    mA )	
IV:	(    mA )	
WL:	(    mA )	
Lot No:		
XXXX-XXXX XXXX / PLSTXXXX	RoHS PASS	

- ☰ Part No : Product Number
- ☰ O Item : Customer's Product Number
- ☰ N Item : Product Name
- ☰ Q'TY : Packing Quantity
- ☰ VF : Voltage Rank
- ☰ IV : Luminous Intensity Rank
- ☰ WL : Wavelength Rank
- ☰ Lot No : Lot Number
- ☰ MSL : MSL Level
- ☰ XXXX-XXXX XXXX / PLSTXXXX : Identify Label Number

## Dry Packing Process and Materials

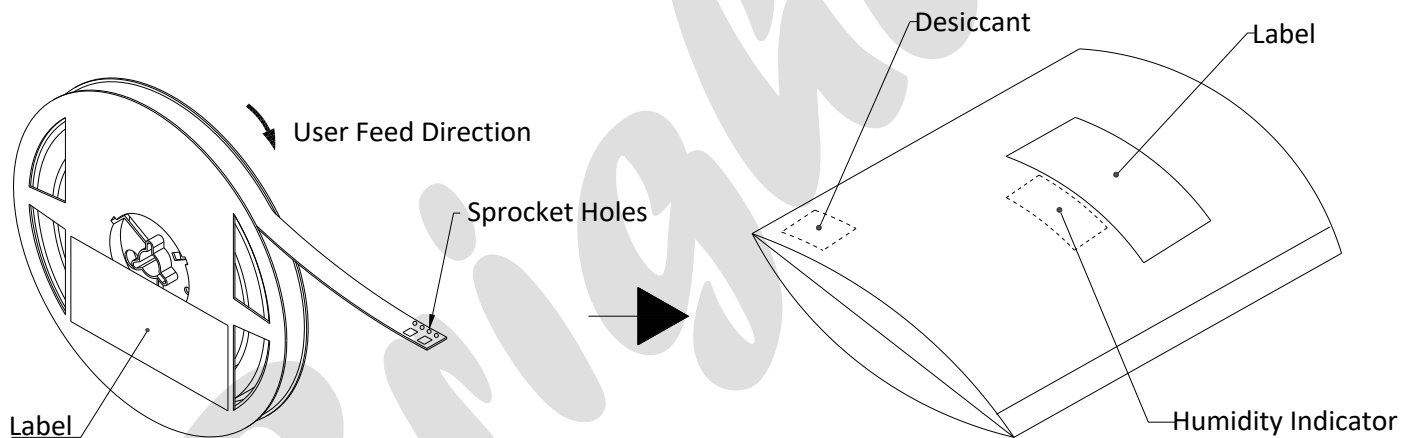

1. Moisture-sensitive product is packed in a dry bag containing desiccant and a humidity card according JEDEC-STD-033.

## Disclaimer

1. Brightek reserves the right(s) on the adjustment of product material mix for the specification.
2. The product meets Brightek published specification for a period of one year from date of shipment.
3. The graphs shown in this datasheet are representing typical data only and do not show guaranteed values.
4. When using this product, please observe the absolute maximum ratings and the instructions for using outlined in these specification sheets. Brightek assumes no responsibility for any damage resulting from the use of the product which does not comply with the absolute maximum ratings and the instructions included in these specification sheets.
5. These specification sheets include materials protected under copyright of Brightek. Reproduction in any form is prohibited without obtaining Brightek's prior consent.
6. This product is not intended to be used for military, aircraft, life sustaining or life saving applications or any other application which can result in human injury or death. Please contact authorized Brightek sales agent for special application request.