

## SA0603A97BBNA Datasheet

0603 Series (L\* W\*H): 1.6\*1.0\*0.80mm



### Applications

- Indicator and backlighting for all consumer electronics
- Special application

### Features

- Forward current:  $\leq 20\text{mA}$  ;
- Typical view angle 50% Iv:55°
- Good thermal dissipation & optical uniformity
- Lens color: Black
- Emitting color: Amber
- RoHS2.0 and REACH-compliant
- ESD level 2kV(HBM)

# SA0603A97BBNA

## Dimensional Drawing

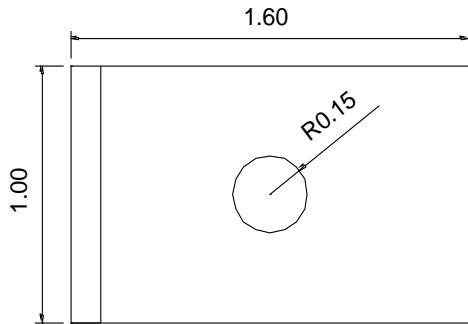

Top View

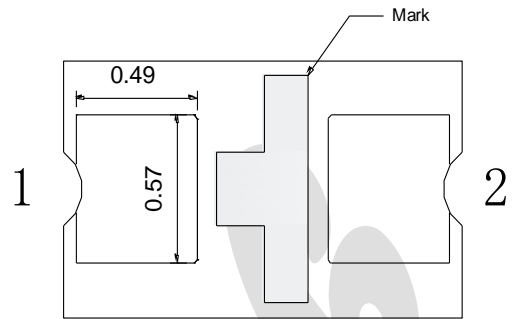

Bottom View

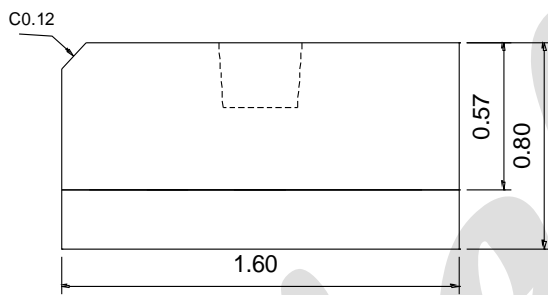

Side View

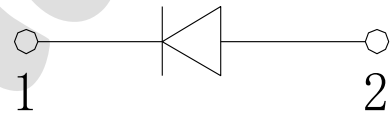

## Recommend Padlayout

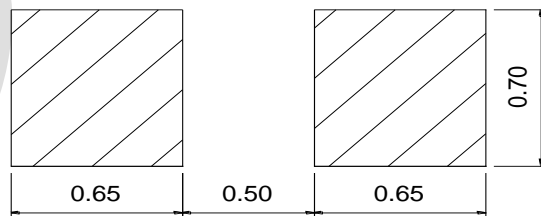

1. Dimensions are in millimeters.
2. General tolerance is  $\pm 0.1$ mm.

# SA0603A97BBNA

## Naming Rule

### SA-0603-A97-B-B-NA

SA	0603	A97	B	B	NA
Type	Package Size	Color	Lens color	Output current	Serial number
SA: PCB planar LED	0603: 1.6*1.0mm	A**:Amber	B:Black	B:5mA	N: no zener A: Serial number

## Maximum Ratings

T<sub>A</sub> : 25 °C

Parameter	Symbol		Typical	Unit
Forward current	I <sub>F</sub>	max.	20	mA
Pulse forward current	I <sub>PF</sub>	max.	80	mA
Power Dissipation	P <sub>D</sub>	max.	60	mW
Reverse voltage	V <sub>R</sub>	max.	5	V
Junction temperature	T <sub>j</sub>	max.	110	°C
Operating temperature	T <sub>op</sub>	min.	-40	°C
		max.	85	
Storage temperature	T <sub>stg</sub>	min.	-40	°C
		max.	100	
Soldering temperature	T <sub>SD</sub>	max.	260	°C

1. There is no maximum or typical voltage parameter.
2. For other ambient, limited setting of current will be depended on de-rating curves.
3. Duty 1/10, pulse width 0.1ms.
4. The maximum of soldering time is 10 seconds in T<sub>SD</sub>.

# SA0603A97BBNA

## Characteristics

IF : 5mA | TA : 25 °C

Parameter	Symbol		Values	Unit
Dominant wavelength	$\lambda_d$	min.	597	nm
		typ.	-	
		max.	612	
View angle	$2\theta_{1/2}$	typ.	55	°
		min.	8	
Luminous Intensity	$I_V$	typ.	20	mcd
		max.	33	
		min.	1.7	
Forward voltage	$V_F$	typ.	-	V
		max.	2.5	
		max.	10	

1. Tolerance of Measure:

Forward Voltage:  $\pm 0.1V$ , Luminous Intensity:  $\pm 10\%mcd$ , Dominant Wavelength:  $\pm 1.0nm$

# SA0603A97BBNA

## Bin groups

### 1. Luminous Intensity (IF=5mA)

Group		Values	Unit
9	min.	8	mcd
	max.	13	
A	min.	13	
	max.	21	
B	min.	21	
	max.	33	

### 2. Forward Voltage (IF=5mA)

Group		Values	Unit
□	min.	1.7	V <sub>F</sub> (V)
	max.	2.5	

### 3. Dominant Wavelength (IF=5mA)

Group		Values	Unit
A	min.	597	nm
	max.	604.5	
B	min.	604.5	
	max.	612	

# SA0603A97BBNA

## Typical Electrical Optical Characteristics Curves

Radiation Characteristics

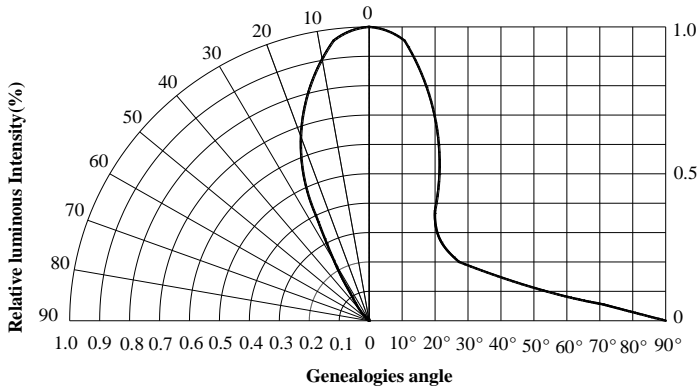

Forward Voltage

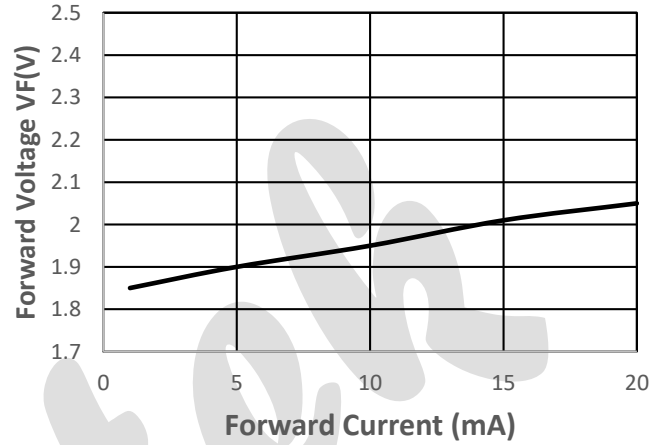

Relative Luminous Intensity

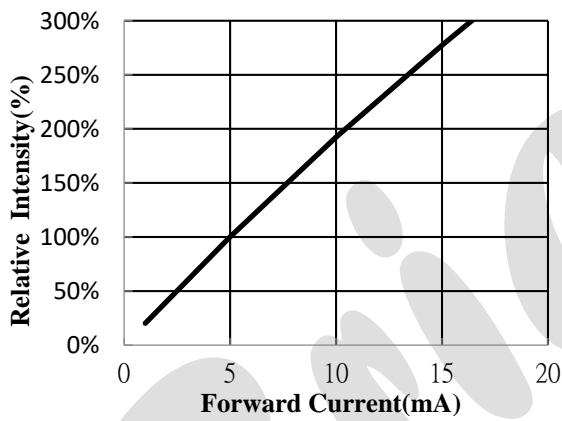

Relative Luminous Intensity vs. Temperature

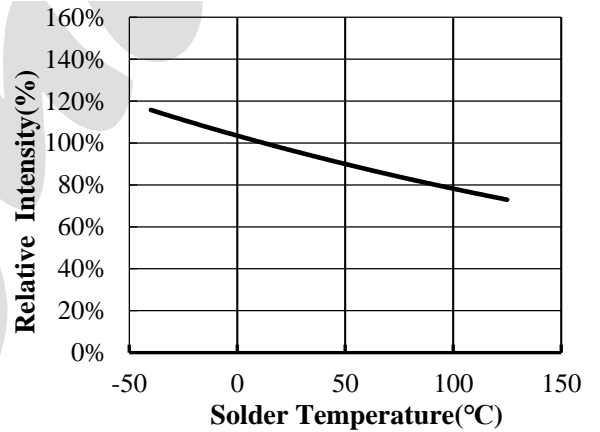

Permissible Forward Current

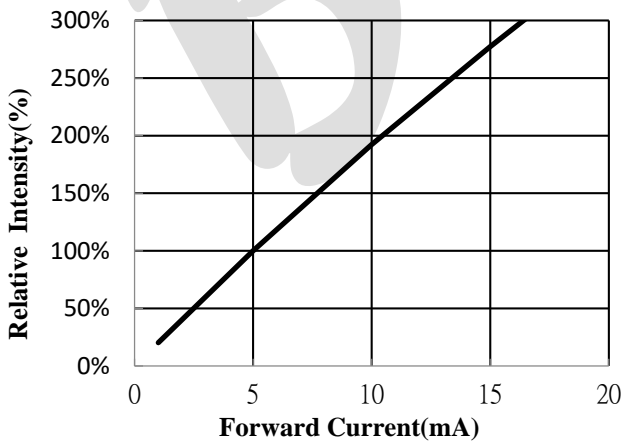

Relative Spectral Emission

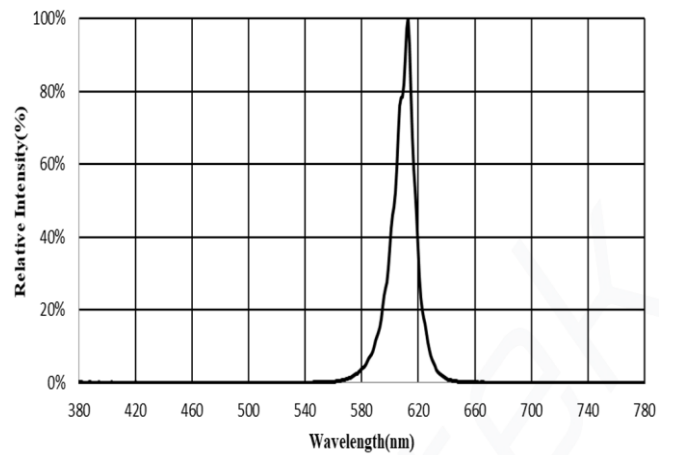

## Reflow Soldering Profile

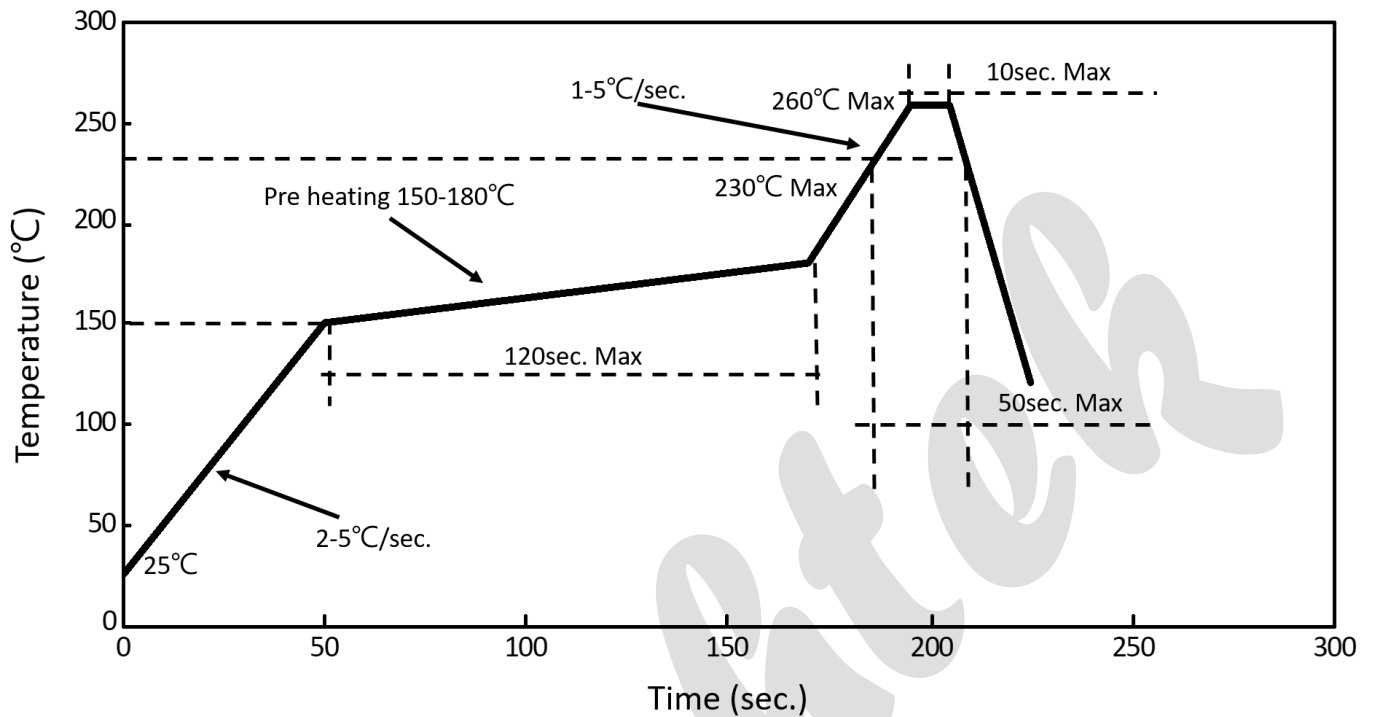

1. We recommend the reflow temperature 240°C ( $\pm 5^\circ\text{C}$ ). the maximum soldering temperature should be limited to 260°C.
2. Do not stress the silicone resin while it is exposed to high temperature.
3. The reflow process should not exceed 3 times.

## Test Circuit and Handling Precautions

### 1. Test circuit

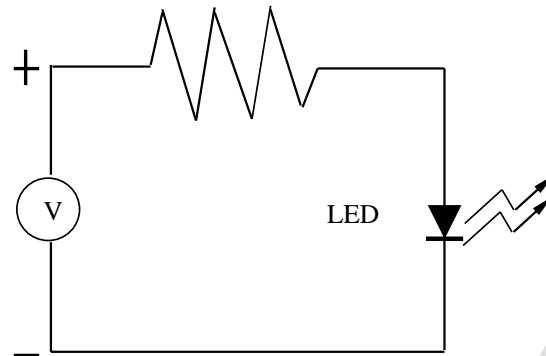

### 2. Handling precautions

#### 2.1 Over-current-proof

Customer must apply resistors for protection; otherwise slight voltage shift will cause big current change (Burn out will happen).

#### 2.2 Storage

① It is recommended to store the products in the following conditions:

- Humidity: 60% R.H. Max.
- Temperature :  $5^{\circ}\text{C} \sim 30^{\circ}\text{C}$  ( $41^{\circ}\text{F} \sim 86^{\circ}\text{F}$ )

② Shelf life in sealed bag: 12 month at  $< 5^{\circ}\text{C} \sim 30^{\circ}\text{C}$  and  $< 60\%$  R.H. after the package is Opened, the products should be used within 1 week or they should be keeping to storage at  $\leq 20\%$  R.H. with zip-lock sealed.

#### 2.3 Baking

Suggest packing open after 1 week, before use baking products, conditions as follows:

- ①  $60 \pm 3^{\circ}\text{C}$  X 6hrs and  $< 5\%$  RH, for reel
- ②  $125 \pm 3^{\circ}\text{C}$  X 2hrs, for single LED

It shall be normal to see slight color fading of carrier (light yellow) after baking in process.



## Tapping

### 1. Dimensions of Tape (Unit: mm)

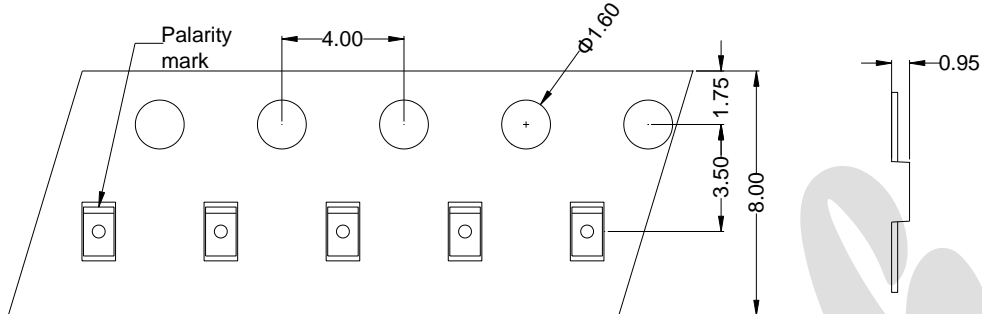

### 2. Arrangement of Tape

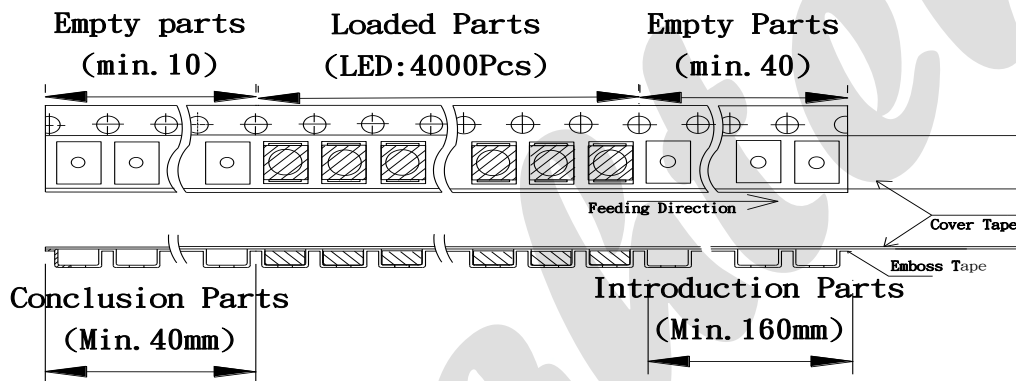

### 3. Dimensions of Reel (Unit: mm)



#### Notes:

1. Empty component pockets are sealed with top cover tape
2. The max loss number of SMD is 2pcs
3. The cathode is oriented towards the tape sprocket hole in accordance with ANSI/EIA RS-481 specifications
4. 4,000pcs per reel
5. The remainder packing in multiples of 500pcs.

## Packing

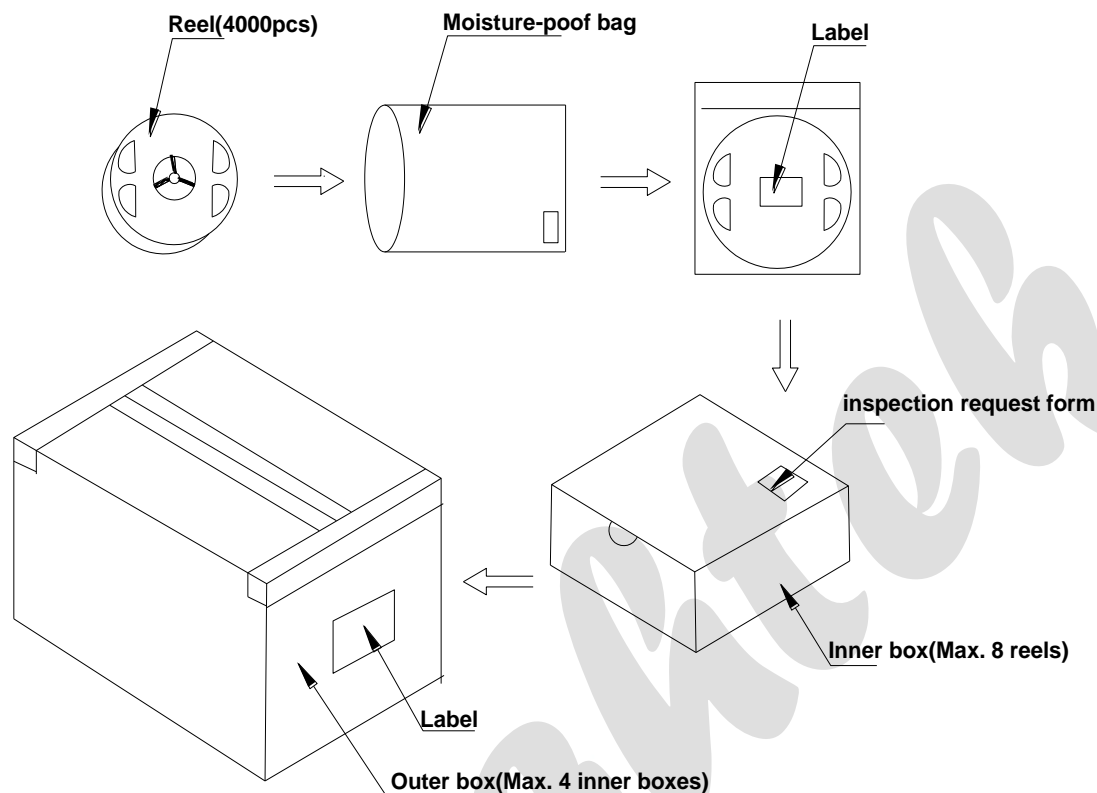

Reeled product (max.4,000 ) is packed in a sealed moisture-proof bag. eight bags are packed in an inner box (size: about 260 X 230 X 100 mm) and four inner boxes are in an outer box (size: about 480 X 275 X 215 mm). On the label of moisture-pooof bag, there should be the information of Part No., Lot No. and quantity number; also the total quantity number should be on inspection request form on outer box.

## Precautions

### 1. Abnormal situation caused by improper setting of collet

To choose the right collet is the key issue in improving the product's quality. LED is different from other electronic components, which is not only about electrical output but also for optical output. This characteristic made LED more fragile in the process of SMT. If the collet's lowering down height is not well set, it will bring damage to the gold wire at the time of collet's picking up and loading which will cause the LED fail to light up, light up now and then or other quality problems.

### 2. How to choose the collet

During SMT, please choose the collet that has larger outer diameter than the lighting area of lens, in case that improper position of collet will damage the gold wire inside the LED. Different collets fit for different products, please refer to the following pictures cross out.

**Outer diameter of collet should be larger than the lighting area**

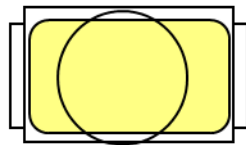

Picture 1 (✓)

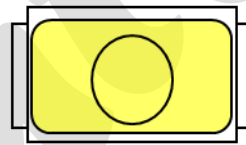

Picture 2 (X)

### 3. Other points for attention

- No pressure should be exerted to the epoxy shell of the SMD under high temperature.
- Do not scratch or wipe the lens since the lens and gold wire inside are rather fragile and cross out easy to break.
- CLED should be used as soon as possible when being taken out of the original package, and should be stored in anti-moisture and anti-ESD package.

### 4. This usage and handling instruction is only for your reference.